

# Product Overview

*Offering a complete solution<sup>®</sup>*

Wide range of white, coloured and foiled woodgrain PVC-UE  
roofline boards, window trims and cladding planks.

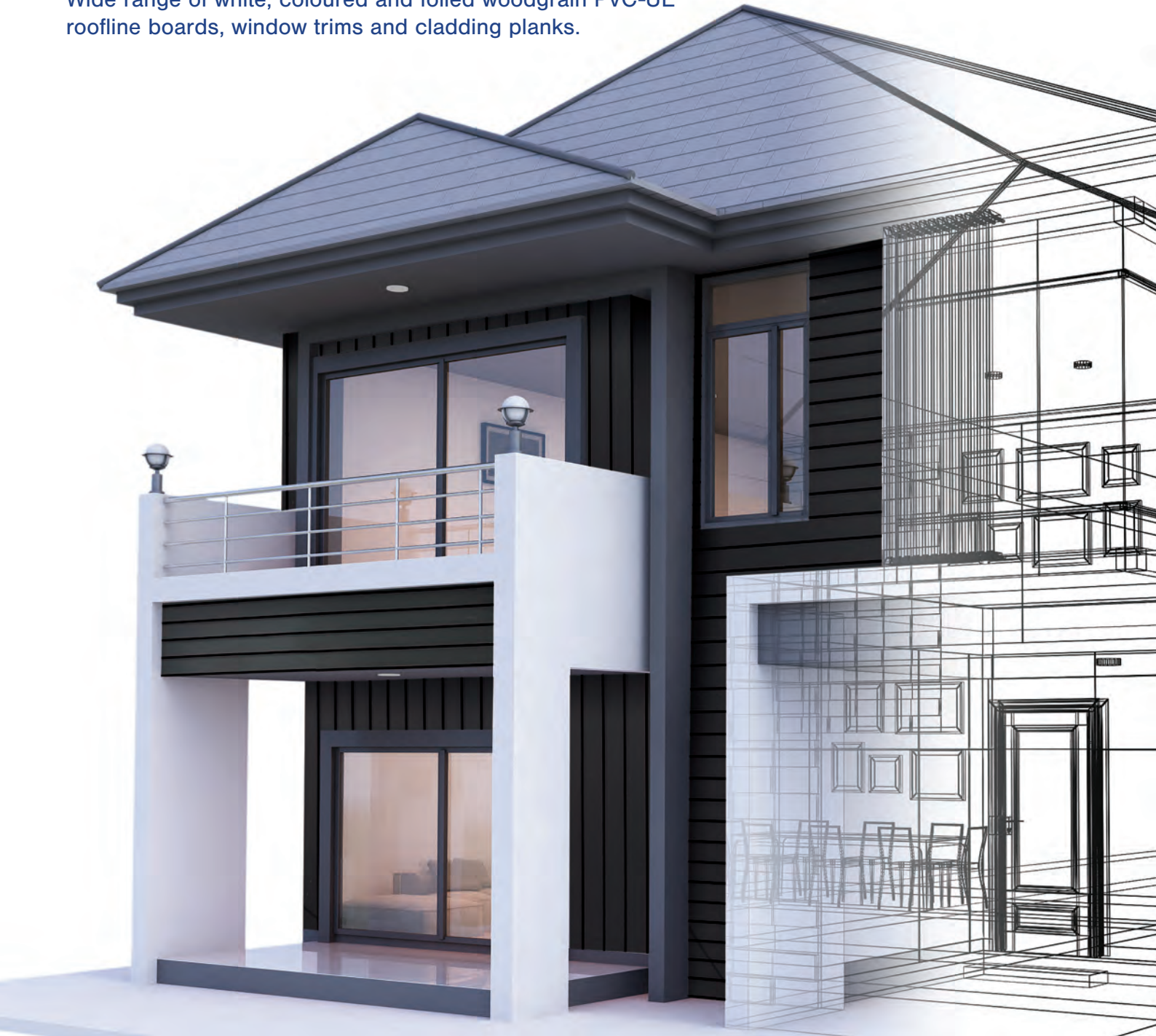

Fascias | Soffits | Cladding | Windowboards | Architraves | Decking



[www.kbp.co.uk](http://www.kbp.co.uk)

**KESTREL**<sup>®</sup>  
rely on it

## Our Mission Statement

*"To be a leading supplier and manufacturer of plastic products to the building industry."*

## Customer Charter

**Our Customer Charter sets out the minimum expectations that we, as a business, endeavour to achieve when building relations with our customers and suppliers.**

- We have a customer focused approach and a clear commitment to being and offering the very best - in products and service.
- Our committed and knowledgeable Customer Services Team will deal with all correspondence in a polite and respectful manner.
- We will aim to respond to all enquiries within 48 hours.
- All our customers are provided with set delivery days, where we aim to supply stock products within agreed timescale.
- Our specialised fleet of vehicles along with fully trained drivers, provides a dedicated service which meets customers' needs within the UK.
- Our estimating team who have over 20 years' experience, will do their best to turnaround enquiries under seven days and 99.5% accuracy on drawings or pricing bill of quantities.
- All at Kestrel-BCE are committed to the care of the environment and the prevention of pollution.
- The organisation seeks to minimise waste, promote recycling, reduce energy consumption, reduce harmful emissions and, where possible, to work with suppliers who themselves have sound environmental policies.
- We produce all products to ISO9001 quality and within an environmental management system which satisfies the requirements of BS EN ISO 14001:2004. We are independently certified to BES 6001
- We are confident in our products allowing us to offer the guarantees below:

*Think Customer. Everyone. Every Day*

# Contents



**Roofline** **Page 4**

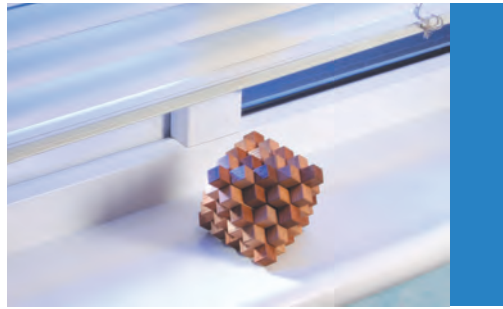

**Windowline** **Page 30**

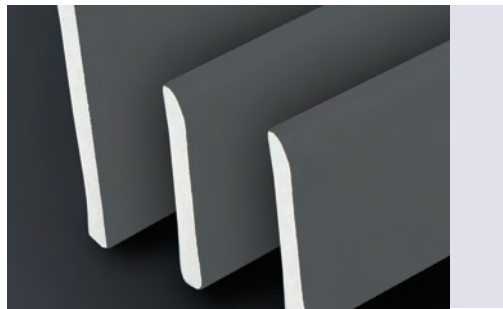

**Trims** **Page 39**



**Cladding** **Page 43**

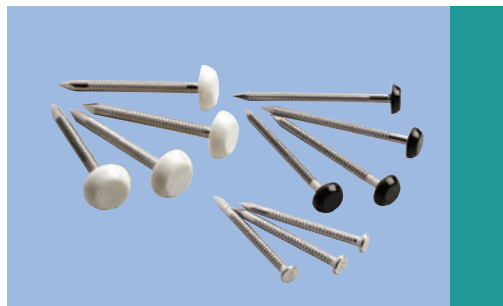

**Fixings** **Page 51**

**NEW**



**Decking**  
**Dekboard** **Page 53**  
**Reverse Dekboard** **Page 69**  
**Fibron** **Page 71**

## K22/Bullnosed Fascia Boards x 22mm

- 22mm load-bearing fascia board with a 25mm bullnose and soffit groove
- Allows direct fixing of rainwater systems without needing timber support

K22/250

Available in the following colours:

Brilliant  
White  
**BW**Mahogany  
**WG**Blackgrain  
**BG**Sherwood  
**SG**Rosewood  
**PG**

Whites: Finish will vary from catalogue, please request a sample.

Product Code	Description	White		Woodgrains					
		Pack Qty	Brilliant White BW	Pack Qty	Mahogany WG	Blackgrain BG	Sherwood SG	Rosewood PG	
K22/150	150mm x 22mm	2 x 5m	✓	1 x 5m	✓	✓	✓	✓	
K22/175	175mm x 22mm	2 x 5m	✓	1 x 5m	✓	✓	✓	✓	
K22/200	200mm x 22mm	2 x 5m	✓	1 x 5m	✓	✓	✓	✓	
K22/225	225mm x 22mm	2 x 5m	✓	1 x 5m	✓	✓	✓	✓	
K22/250	250mm x 22mm	2 x 5m	✓	1 x 5m	✓	✓	✓	✓	
K22/300	300mm x 22mm	1 x 5m	✓	1 x 5m	✓	✓	✓	✓	
K22/355	355mm x 22mm (Double End)	1 x 5m	✓						
K22/405	405mm x 22mm (Double End)	1 x 5m	✓	1 x 5m	✓	✓	✓	✓	
K22/405/1.25	405mm x 22mm (Double End)	1 x 1.25m	✓	1 x 1.25m	✓	✓	✓	✓	

# KB16/Bullnosed Fascia Boards x 16mm

- 16mm load-bearing fascia board with a 25mm bullnose and soffit groove
- Allows direct fixing of rainwater systems without needing timber support.



KB16/150

Available in the following colour:



Brilliant  
White  
**BW**

Whites: Finish will vary from catalogue, please request a sample.

← White →

Product Code	Description	Pack Qty	Brilliant White BW
KB16/150	150mm x 16mm	2 x 5m	✓
KB16/175	175mm x 16mm	2 x 5m	✓
KB16/200	200mm x 16mm	2 x 5m	✓
KB16/225	225mm x 16mm	2 x 5m	✓
KB16/250	250mm x 16mm	2 x 5m	✓
KB16/405	405mm x 16mm (Double End)	1 x 5m	✓

# K22/ KB16/ Accessories - Bullnosed Fascia



Whites: Finish will vary from catalogue, please request a sample.

## K22 & KB16 Accessories Bullnosed Fascias

← White →

Product Code	Description	Pack Qty	Brilliant White BW
K22/693/050	50mm x 25mm End Cap	10 Pairs	✓
K22/694/250	250mm x 25mm End Cap	10 Pairs	✓
K22/695/250	250mm x 30mm Cover Joint	10	✓
K22/696/250	250mm x 40mm External Corner Joint	10	✓
K22/696/600	600mm x 40mm External Corner Joint	5	✓
K22/697/250	250mm Internal Corner Joint	10	✓

## K22 Foiled Accessories Bullnosed Fascia

← Woodgrains →

Product Code	Description	Pack Qty	Woodgrains			
			Mahogany WG	Blackgrain BG	Sherwood SG	Rosewood PG
K22/694/250	250mm x 250mm End Cap	1 Pair	✓	✓	✓	✓
K22/695/250	250mm x 40mm Cover Joint	1	✓	✓	✓	✓
K22/696/250	250mm x 60mm External Corner Joint	1	✓	✓	✓	✓
K22/697/250	250mm Internal Corner Joint	1	✓	✓	✓	✓
K22/698/250	250mm x 60mm External Corner Extension	1	✓	✓	✓	✓
K22/699/250	250mm x 40mm Cover Joint Extension	1	✓	✓	✓	✓

# K16/Square Fascia Boards x 16mm

- 16mm load-bearing, square fascia board with 36mm return leg.
- Allows direct fixing of rainwater systems without needing timber support.

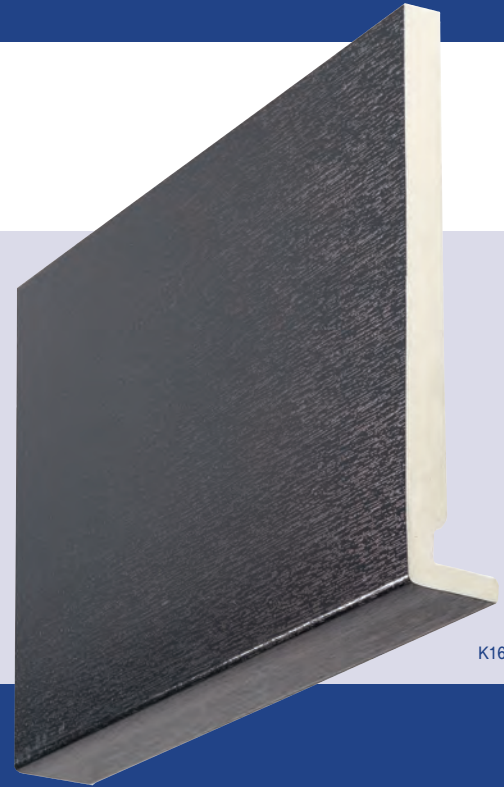

K16/200

Available in the following colours:

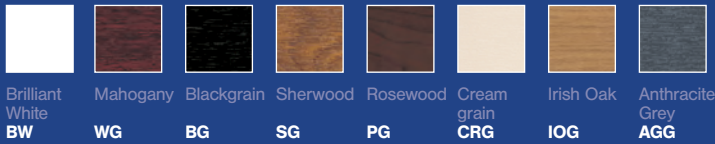

Whites: Finish will vary from catalogue, please request a sample.

Product Code	Description	White		Woodgrains					Premiergrain		
		Pack Qty	Brilliant White BW	Pack Qty	Mahogany WG	Blackgrain BG	Sherwood SG	Rosewood PG	Creamgrain CRG	Irish Oak IOG	Anthracite Grey AGG
K16/150	150mm x 16mm Square	2 x 5m	✓	2 x 5m	✓	✓	✓	✓			✓
K16/175	175mm x 16mm Square	2 x 5m	✓	2 x 5m	✓	✓	✓	✓			✓
K16/200	200mm x 16mm Square	2 x 5m	✓	2 x 5m	✓	✓	✓	✓	✓	✓	✓
K16/225	225mm x 16mm Square	2 x 5m	✓	2 x 5m	✓	✓	✓	✓			✓
K16/250	250mm x 16mm Square	2 x 5m	✓	2 x 5m	✓	✓	✓	✓			✓
K16/355	350mm x 16mm Square (Double End)	1 x 5m	✓								
K16/405	400mm x 16mm Square (Double End)	1 x 5m	✓	1 x 5m	✓	✓	✓	✓	✓	✓	✓
K16/405/1.25	400mm x 16mm Square (Double End)	1 x 1.25m	✓	1 x 1.25m		✓					✓

For corners, joints and end caps see pages 10 and 11

# KF16/ Flush Fascia Boards x 16mm



KF16/649/250



KF16/650/250



KF16/665/250

KF16/250



Available in the following colours:



Brilliant  
White  
**BW**



Blackgrain  
**BG**



Rosewood  
**PG**

Whites: Finish will vary from catalogue, please request a sample.

Product Code	Description	White		Woodgrains		
		Pack Qty	Brilliant White BW	Pack Qty	Blackgrain BG	Rosewood PG
KF16/150	150mm x 16mm Flush	2 x 5m	✓	2 x 5m	✓	✓
KF16/175	175mm x 16mm Flush	2 x 5m	✓			
KF16/200	200mm x 16mm Flush	2 x 5m	✓			
KF16/225	225mm x 16mm Flush	2 x 5m	✓			
KF16/250	250mm x 16mm Flush	2 x 5m	✓	2 x 5m		✓*
KF16/405	405mm x 16mm Flush (Double End)	1 x 5m	✓			

#### Accessories for KF16 - Flush Fascia Boards

KF16/649/250	250mm x 40mm Joint Trim	10	✓			
KF16/650/250	250mm Internal Corner Trim	10	✓			
KF16/665/250	250mm x 16mm End Cap	10	✓		✓*	

\* **Made To Order** Up to three week lead time. Minimum order quantity may apply.



# 605/Reveal Liner - Fascia Capping Boards x 9mm

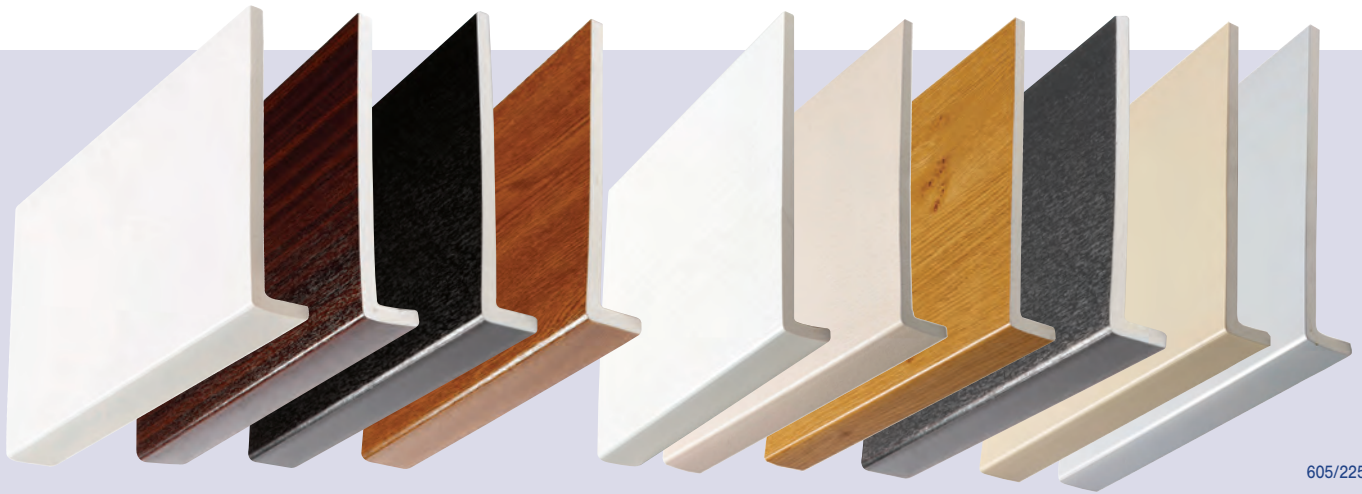

605/225

Available in the following colours:



Whites: Finish will vary from catalogue, please request a sample.

Product Code	Description	Pack Qty	◀ White ▶ Woodgrains ▶ Premiergrain ▶ Colours ▶											
			Brilliant White BW	Mahogany WG	Blackgrain BG	Sherwood SG	Rosewood PG	Whitegrain WHG	Creamgrain CRG	Irish Oak IOG	Anthracite Grey AGG	Sand 1015	Light Grey 7035	
605/100	110mm x 9mm	2 x 5m	✓											
605/125	135mm x 9mm	2 x 5m	✓											
605/150	160mm x 9mm	2 x 5m	✓	✓	✓	✓	✓				✓			
605/175	185mm x 9mm	2 x 5m	✓	✓	✓	✓	✓				✓	✓	✓*	
605/200	210mm x 9mm	2 x 5m	✓	✓	✓	✓	✓				✓	✓	✓	
605/225	235mm x 9mm	2 x 5m	✓	✓	✓	✓	✓	✓	✓	✓	✓	✓*	✓*	
605/250	260mm x 9mm	2 x 5m	✓	✓	✓	✓	✓				✓			
605/300	310mm x 9mm	2 x 5m	✓	✓	✓	✓	✓				✓			
605/405	415mm x 9mm	2 x 5m 1 x 5m	✓	✓	✓	✓	✓				✓			
605/405/1.25	415mm x 9mm	1 x 1.25m	✓		✓						✓			
605/450	450mm x 9mm	1 x 5m	✓											
605/600	605mm x 9mm	1 x 5m	✓											

\* Made To Order Up to three week lead time. Minimum order quantity may apply.

# K16 - KF16 and 605/ Accessories - Square Edge Fascias

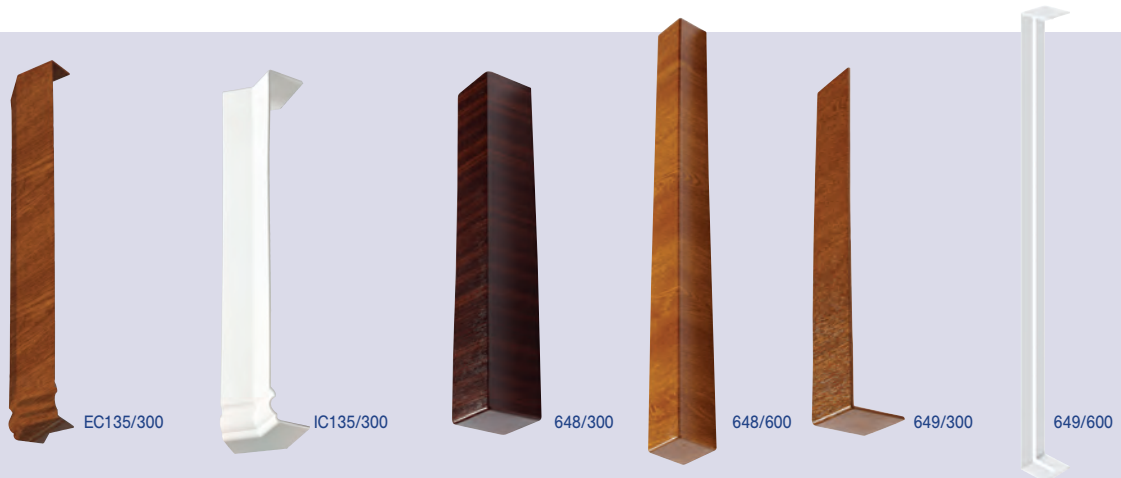

Available in the following colours:

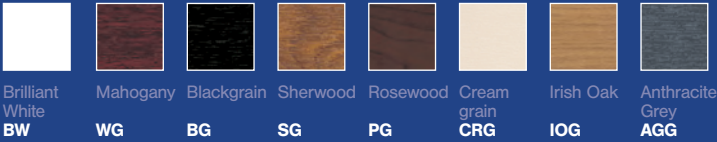

Whites: Finish will vary from catalogue, please request a sample.

Product Code	Description	Pack Qty	White		Woodgrains					Premiergrain		
			Brilliant White BW	Mahogany WG	Blackgrain BG	Sherwood SG	Rosewood PG	Creamgrain CRG	Irish Oak IOG	Anthracite Grey AGG		
EC135/300	External 135° Corner Joint (D/E Square / Ogee)	5	✓	✓	✓	✓	✓				✓	
IC135/300	Internal 135° Corner Joint (D/E Square / Ogee)	5	✓	✓	✓	✓	✓					
648/300	300mm x 40mm Slimline External Corner Joint	10 5	✓	✓	✓	✓	✓	✓	✓	✓	✓	
648/600	600mm x 40mm Slimline External Corner Joint	5	✓	✓	✓	✓	✓	✓	✓	✓	✓	
649/300	300mm x 40mm Slimline Cover Joint	10 5	✓	✓	✓	✓	✓	✓	✓	✓	✓	
649/600	600mm x 40mm Slimline Cover Joint	5	✓									

\* Made To Order Up to three week lead time. Minimum order quantity may apply.

# K16 - KF16 and 605/Accessories - Square Edge Fascias



Available in the following colours:



Whites: Finish will vary from catalogue, please request a sample.

← White → Woodgrains Premiergrain → Colours →

Product Code	Description	Pack Qty	Available in the following colours:											
			Brilliant White BW	Mahogany WG	Blackgrain BG	Sherwood SG	Rosewood PG	White grain WHG	Cream grain CRG	Irish Oak IOG	Anthracite Grey AGG	Sand 1015	Light Grey 7035	Black BL
650/300	300mm Internal Corner Joint	10 5	✓	✓	✓	✓	✓			✓	✓	✓	✓	✓
665/050	50mm Fascia End Cap for K16 / 605	10	✓											
665/250	250mm Fascia End Cap for K16 / 605	10	✓	✓	✓	✓	✓			✓	✓*	✓		✓*
448/300	300mm x 60mm Premium External Corner Joint & Upstand	10 5	✓			✓*	✓			✓*		✓		✓*
448/EXT	250mm x 60mm Premium External Corner Extension	10	✓											
449/300	300mm x 50mm Premium Cover Joint With Upstand	10 5	✓			✓*	✓*			✓*		✓		✓*

\* Made To Order Up to three week lead time. Minimum order quantity may apply.

## 505/Reveal Liner - Long Leg Boards x 8mm

- 8mm square edge, fascia capping board with 44mm return leg
- Requires a new timber sub-fascia when being used as a fascia board

505/150

Available in the following colour:



Brilliant  
White  
**BW**



Whites: Finish will vary from catalogue, please request a sample.

← White →

Product Code	Description	Pack Qty	Brilliant White BW
505/150	150mm x 8mm Long Leg	2 x 5m	✓
505/175	175mm x 8mm Long Leg	2 x 5m	✓
505/200	200mm x 8mm Long Leg	2 x 5m	✓
505/225	225mm x 8mm Long Leg	2 x 5m	✓
505/250	250mm x 8mm Long Leg	2 x 5m	✓
505/355	355mm x 8mm Long Leg (Double End)	2 x 5m	✓
505/405	405mm x 8mm Long Leg (Double End)	2 x 5m	✓

## 505/ Accessories - Reveal Liner - Long Leg x 8mm

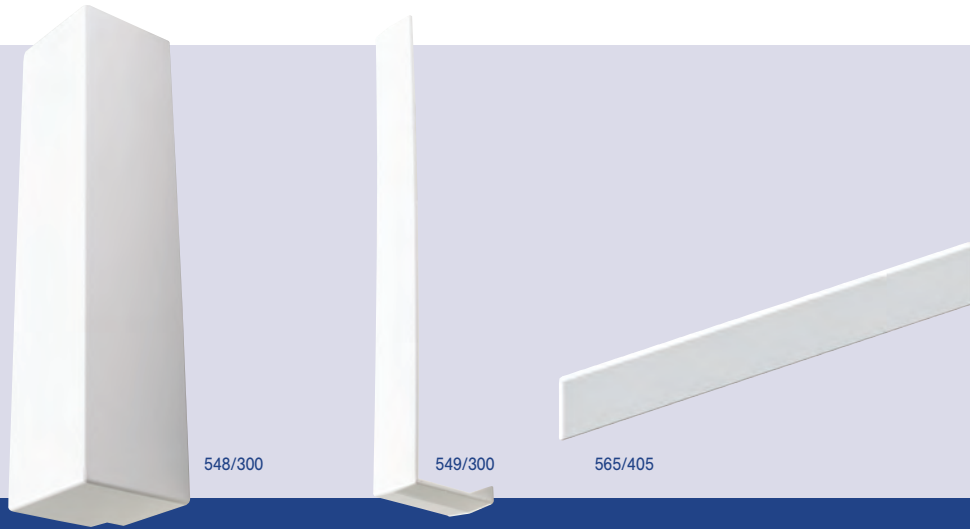

Available in the following colour:



Brilliant  
White  
**BW**

Whites: Finish will vary from catalogue, please request a sample.

← White →

Product Code	Description	Pack Qty	Brilliant White BW
548/300	300mm x 60mm Long Leg Ext Corner	10	✓
549/300	300mm x 30mm Long Leg Cover	10	✓
565/405	405mm x 44mm Long Leg End Cap	10	✓

## 018/Ogee Fascia Boards x 18mm

- 18mm load bearing, Ogee fascia board with 42mm return leg
- Allows direct fixing of rainwater systems without needing timber support

018/175



018/405



Available in the following colour:



Brilliant  
White  
**BW**

Whites: Finish will vary from catalogue, please request a sample.

← White →

Product Code	Description	Pack Qty	Brilliant White BW
018/150	150mm x 18mm	2 x 5m	✓
018/175	175mm x 18mm	2 x 5m	✓
018/200	200mm x 18mm	2 x 5m	✓
018/225	225mm x 18mm	2 x 5m	✓
018/250	250mm x 18mm	2 x 5m	✓
018/405	405mm x 18mm (Double End)	1 x 5m	✓

# 018/Accessories - Ogee Fascia x 18mm



Available in the following colour:



Brilliant White  
**BW**

Whites: Finish will vary from catalogue, please request a sample.

← White →

Product Code	Description	Pack Qty	Brilliant White BW
0180/300	300mm Internal Corner Joint	5	✓
0188/300	300mm x 50mm External Corner Joint	5	✓
0189/300	300mm x 40mm Cover Joint	5	✓

# 008/Ogee Fascia Boards x 8mm

- 8mm Ogee fascia board with 35mm return leg
- Requires a new timber sub-fascia when being used as a fascia board



008/175

Available in the following colours:

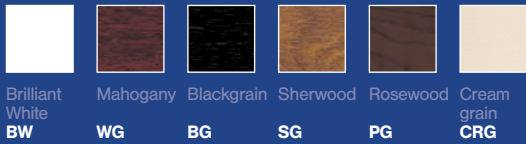

Whites: Finish will vary from catalogue, please request a sample.

Product Code	Description	White		Woodgrains					Premiergrain
		Pack Qty	Brilliant White BW	Pack Qty	Mahogany WG	Blackgrain BG	Sherwood SG	Rosewood PG	Creamgrain CRG
008/150	150mm x 8mm	2 x 5m	✓						
008/175	175mm x 8mm	2 x 5m	✓	2 x 5m	✓	✓	✓	✓	✓
008/200	200mm x 8mm	2 x 5m	✓	2 x 5m	✓	✓	✓	✓	✓
008/225	225mm x 8mm	2 x 5m	✓	2 x 5m	✓	✓	✓	✓	✓
008/250	250mm x 8mm	2 x 5m	✓						
008/405	405mm x 8mm (Double End)	2 x 5m	✓	2 x 5m	✓	✓	✓	✓	✓

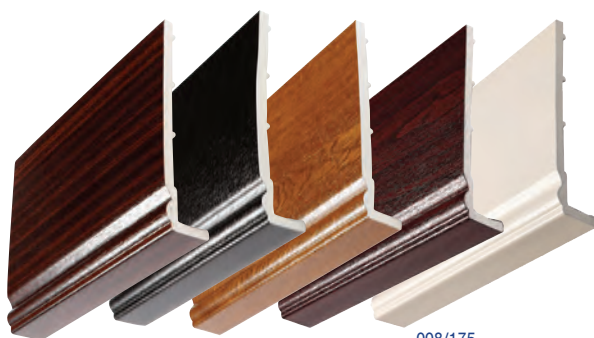

008/175

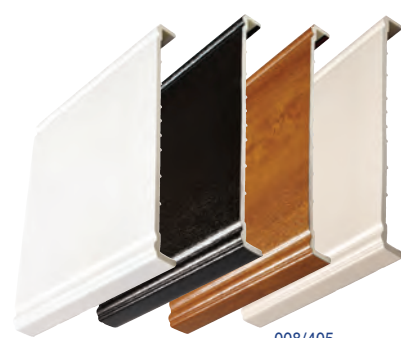

008/405



# 008/Accessories - Ogee Fascia x 8mm

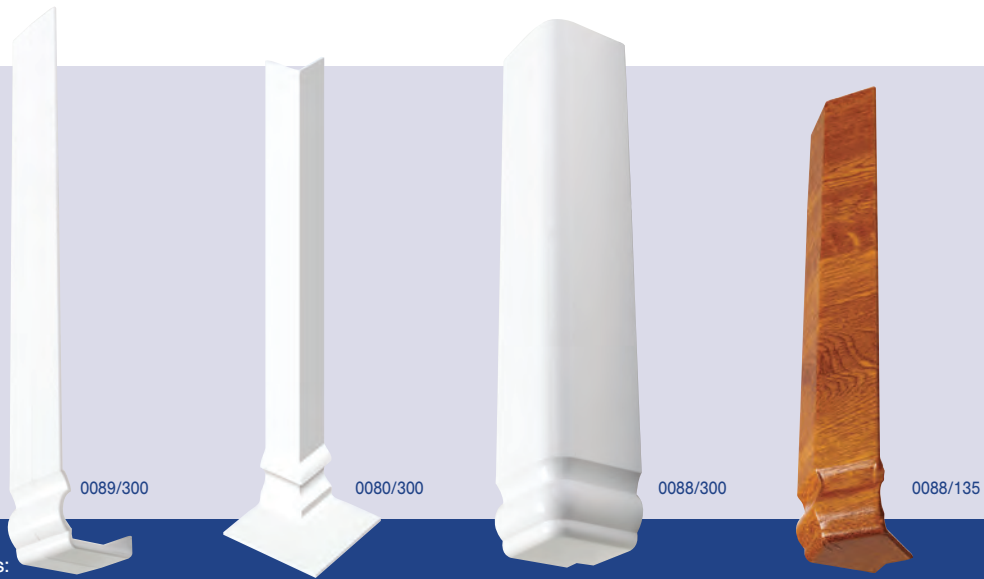

Available in the following colours:



Whites: Finish will vary from catalogue, please request a sample.

Product Code	Description	White		Woodgrains					Premiergrain
		Pack Qty	Brilliant White BW	Pack Qty	Mahogany WG	Blackgrain BG	Sherwood SG	Rosewood PG	Creamgrain CRG
0089/300	300mm x 40mm Cover Joint	10	✓	5	✓	✓	✓	✓	✓
0088/300	300mm x 50mm External Corner Joint	10	✓						
0080/300	300mm Internal Corner Joint	10	✓						
0088/135	300mm 135° External Corner Joint	5	✓	5					

# Image Range/Waveline x 16mm



VCREST



VWAVE



K714



K714/060

Available in the following colours:



Brilliant  
White  
**BW**



White  
**W**



Whites: Finish will vary from catalogue, please request a sample.

Product Code	Description	Pack Qty	Whites		
			Brilliant White <b>BW</b>	White <b>W</b>	
<b>Image Range</b>					
<b>V-CREST</b>	220mm x 16mm Convex Ornate	2 x 5m	✓		
<b>V-WAVE</b>	220mm x 16mm Concave Ornate	2 x 5m	✓		
<b>2D Finials</b>					
<b>K714</b>	350mm x 95mm 2D Finial	10	✓		
<b>K714/060</b>	310mm x 60mm 2D Finial	10	✓		

# 603/ Soffit-General Purpose Boards x 9mm

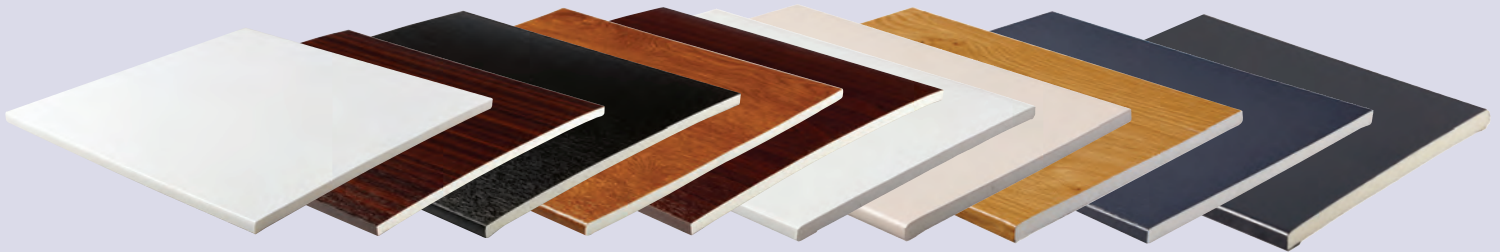

603

Available in the following colours:



Whites: Finish will vary from catalogue, please request a sample.

Product Code	Description	Pack Qty	← White → Woodgrains Premiergrain Smoothgrain →												
			Brilliant White BW	Mahogany WG	Blackgrain BG	Sherwood SG	Rosewood PG	Whitegrain WHG	Creamgrain CRG	Irish Oak IOG	Anthracite Grey AGG	Anthracite Smooth Grey ASG	Slate Smooth Grey SSG		
603/100	100mm Plain Soffit	5 x 5m 2 x 5m	✓	✓	✓	✓	✓								
603/125	125mm Plain Soffit	5 x 5m	✓												
603/150	150mm Plain Soffit	5 x 5m 2 x 5m	✓	✓	✓	✓	✓				✓	✓	✓	NEW ✓	
603/175	175mm Plain Soffit	5 x 5m 2 x 5m	✓	✓	✓	✓	✓								
603/200	200mm Plain Soffit	5 x 5m 2 x 5m	✓	✓	✓	✓	✓		✓	✓	✓				
603/225	225mm Plain Soffit	5 x 5m 2 x 5m	✓	✓	✓	✓	✓	✓	✓	✓	✓				
603/250	250mm Plain Soffit	5 x 5m 2 x 5m	✓	✓	✓	✓	✓				✓				
603/275	275mm Plain Soffit	2 x 5m 2 x 5m	✓				✓								
603/300	300mm Plain Soffit	2 x 5m 2 x 5m	✓	✓	✓	✓	✓	✓	✓	✓	✓				
603/330	330mm Plain Soffit	2 x 5m	✓												
603/400	400mm Plain Soffit	2 x 5m 2 x 5m	✓	✓	✓	✓	✓	✓	✓	✓	✓				
603/450	450mm Plain Soffit	1 x 5m	✓												
603/500	500mm Plain Soffit	1 x 5m	✓												
603/600	600mm Plain Soffit	1 x 5m	✓												

\* Made To Order Up to three week lead time. Minimum order quantity may apply.

## 603/F/Soffit Boards - Two Finished Edges x 9mm

→ 9mm multi-purpose board

→ Two finished edges

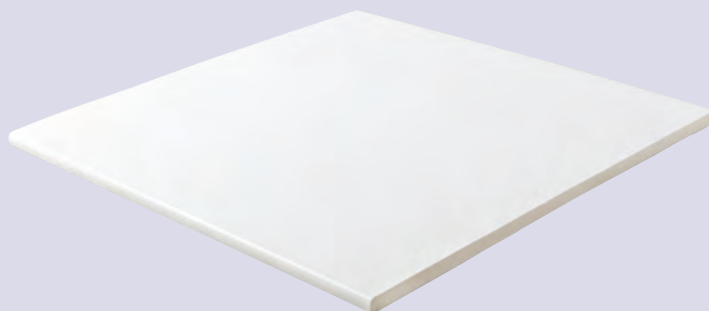

603/300/F

Available in the following colour:



Brilliant  
White  
**BW**

Whites: Finish will vary from catalogue, please request a sample.

← White →

Product Code	Description	Pack Qty	Brilliant White BW
603/100/F	100mm Two Finished Edges	5 x 5m	✓
603/150/F	150mm Two Finished Edges	5 x 5m	✓
603/175/F	175mm Two Finished Edges	5 x 5m	✓
603/200/F	200mm Two Finished Edges	5 x 5m	✓
603/300/F	300mm Two Finished Edges	2 x 5m	✓
603/400/F	405mm Two Finished Edges	2 x 5m	✓

# 803/Ventilated Soffit Boards x 9mm (10mm Air Gap)

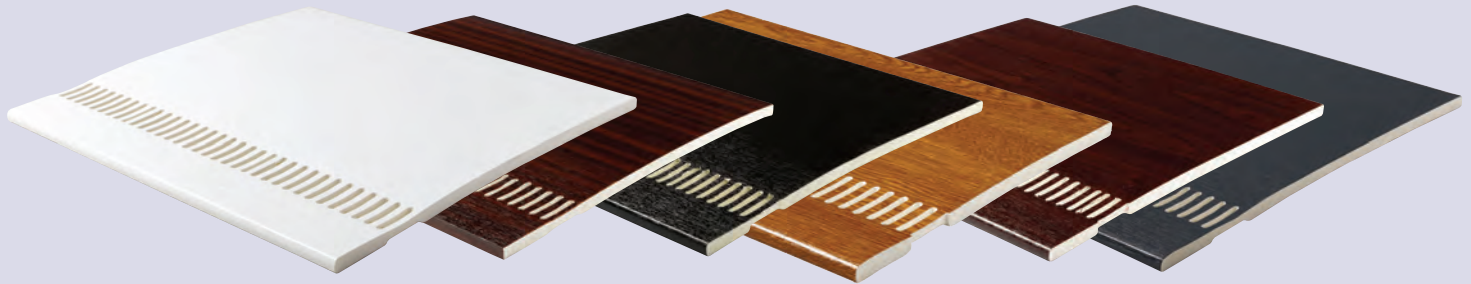

803/400

Available in the following colours:



Whites: Finish will vary from catalogue, please request a sample.

Product Code	Description	White		Woodgrains				Premiergrain
		Pack Qty	Brilliant White BW	Pack Qty	Mahogany WG	Blackgrain BG	Sherwood SG	Rosewood PG
803/100	100mm (10mm air gap)	5 x 5m	✓					
803/150	150mm (10mm air gap)	5 x 5m	✓	2 x 5m	✓	✓	✓	
803/175	175mm (10mm air gap)	5 x 5m	✓					
803/200	200mm (10mm air gap)	5 x 5m	✓	2 x 5m		✓		✓
803/225	225mm (10mm air gap)	5 x 5m	✓	2 x 5m	✓	✓	✓	
803/250	250mm (10mm air gap)	5 x 5m	✓					
803/300	300mm (10mm air gap)	2 x 5m	✓	2 x 5m	✓	✓	✓	✓
803/330	325mm (10mm air gap)	2 x 5m	✓					
803/400	400mm (10mm air gap)	2 x 5m	✓	2 x 5m	✓	✓	✓	✓
803/450	450mm (10mm air gap)	1 x 5m	✓					
803/500	500mm (10mm air gap)	1 x 5m	✓					
803/600	600mm (10mm air gap)	1 x 5m	✓					

## 903/ Double Vented Soffit Boards x 9mm (25mm Air Gap)

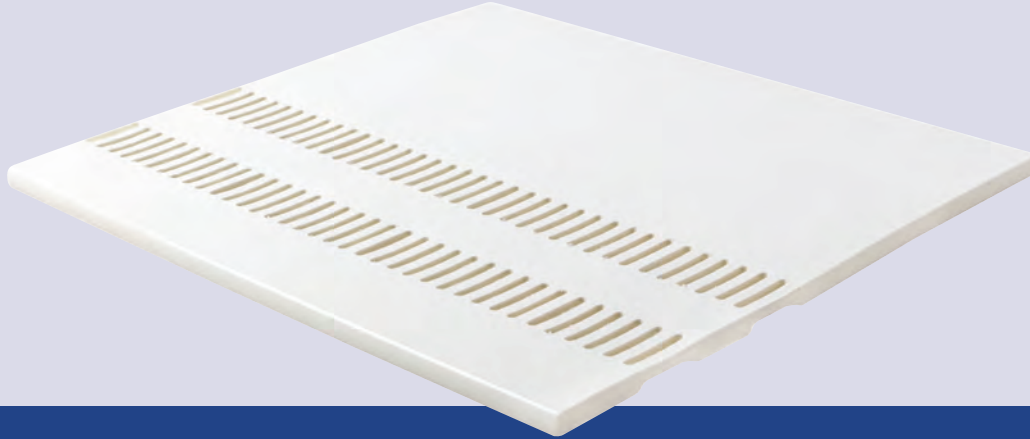

903/300

Available in the following colour:



Brilliant  
White  
**BW**

Whites: Finish will vary from catalogue, please request a sample.

← White →

Product Code	Description	Pack Qty	Brilliant White BW
903/200	200mm (25mm air gap)	5 x 5m	✓
903/300	300mm (25mm air gap)	2 x 5m	✓
903/400	400mm (25mm air gap)	2 x 5m	✓

# 690/Simulated T & G x 9mm

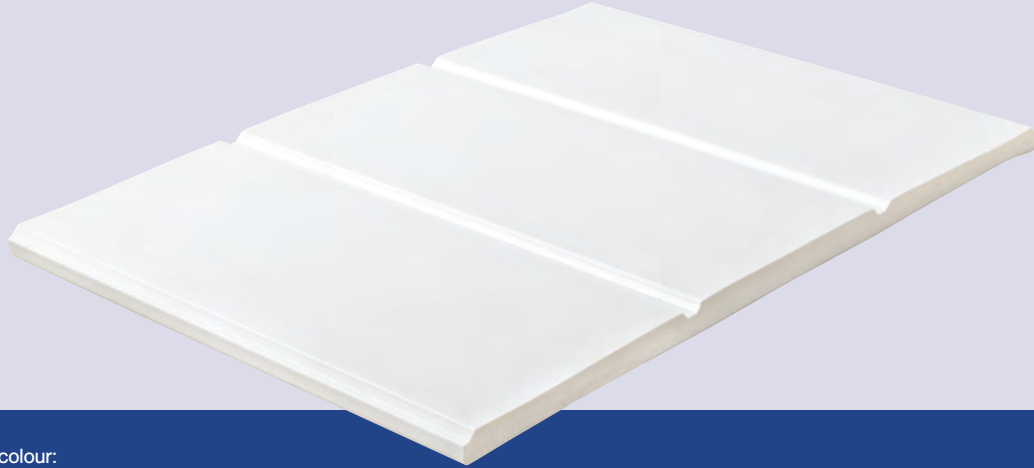

690/300

Available in the following colour:



Brilliant  
White  
**BW**

Whites: Finish will vary from catalogue, please request a sample.

← White →

Product Code	Description	Pack Qty	Brilliant White BW
690/300	300mm x 9mm Simulated Tongue & Groove	2 x 5m	✓

# PVC-U Clip Lock/Hollow Soffit



1005

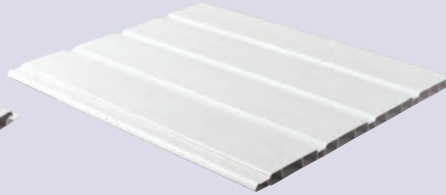

2505

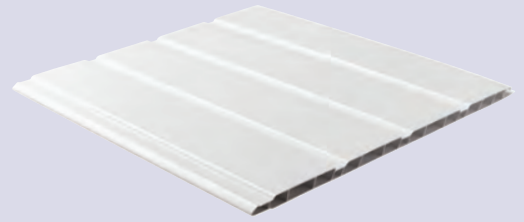

4005

Available in the following colours:



Brilliant White  
**BW**



Sand  
**1015**



Light Grey  
**7035**

Whites: Finish will vary from catalogue, please request a sample.

← White → Colours →

Product Code	Description	Pack Qty	Colours		
			Brilliant White <b>BW</b>	Sand <b>1015</b>	Light Grey <b>7035</b>
<b>1005</b>	100mm PVCU Clip Lock Hollow Soffit	10 x 5m	✓		
<b>2505</b>	250mm x 4 Plank PVCU Clip Lock Hollow Soffit	5 x 5m	✓	✓	✓
<b>4005</b>	400mm x 4 Plank PVCU Clip Lock Hollow Soffit	4 x 5m	✓		

NB: Above items cannot be mixed and matched



## PVC-U Clip Lock/ Hollow Soffit

## PVC-U Push Fit/ Hollow Soffit

→ Simulated Tongue & Groove Hollow Soffit with a hidden fix

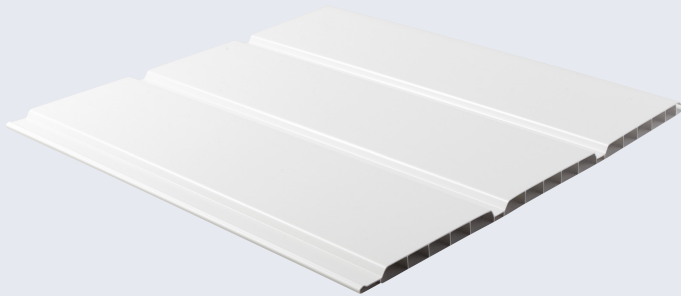

HSL3005

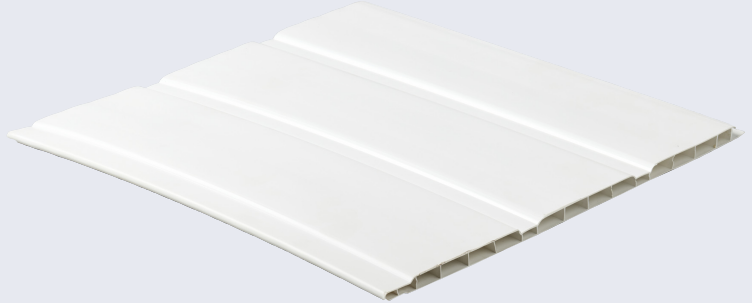

HOLL3005

Available in the following colour:



White

**GW**

Available in the following colours:



Brilliant White  
**BW**



Mahogany  
**WG**



Blackgrain  
**BG**



Sherwood  
**SG**



Rosewood  
**PG**



White grain  
**WHG**



Cream grain  
**CRG**



Irish Oak  
**IOG**



Anthracite Grey  
**AGG**

Whites: Finish will vary from catalogue, please request a sample.

Whites: Finish will vary from catalogue, please request a sample.

### PVC-U Clip Lock

← White →

Product Code	Description	Pack Qty	White
<b>HSL3005</b>	300mm PVCU Clip Lock Hollow Soffit	5 x 5m	<b>GW</b> ✓

NB: Above item is not compatible with Kestrel PVC-U Push Fit

### PVC-U Push Fit

← White → Woodgrains Premiergrain →

Product Code	Description	Pack Qty	Woodgrains							Premiergrain			
			Brilliant White GW	Pack Qty	Mahogany WG	Blackgrain BG	Sherwood SG	Rosewood PG	Whitegrain WHG	Creamgrain CRG	Irish Oak IOG	Anthracite Grey AGG	
<b>HOLL3005</b>	300mm PVCU Push Fit Hollow Soffit <i>NB: Not compatible with any other hollow soffit</i>	5 x 5m	✓	5 x 5m	✓	✓	✓	✓	✓	✓*	✓	✓	✓

\* **Made To Order** Up to three week lead time. Minimum order quantity may apply.

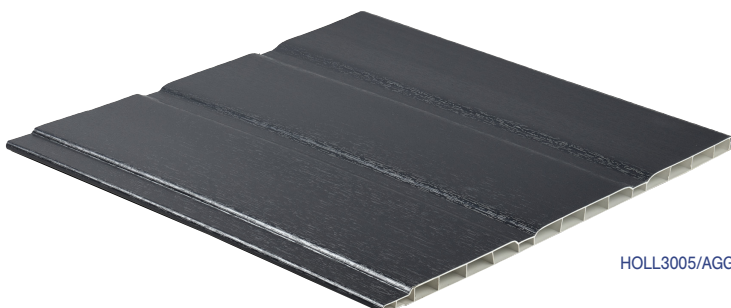

HOLL3005/AGG

# General Purpose/Accessories - Soffit and General Purpose Board

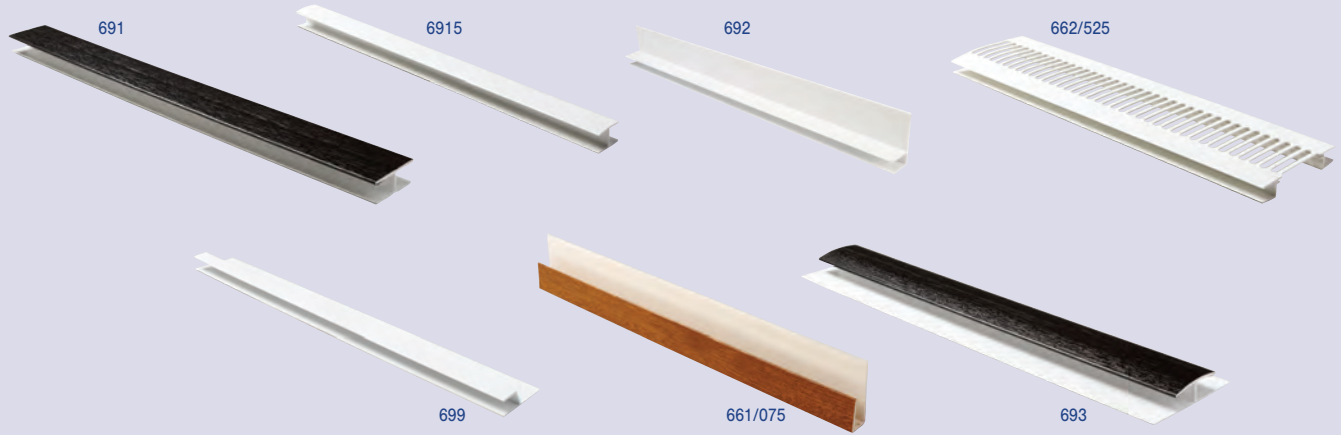

Available in the following colours:



Whites: Finish will vary from catalogue, please request a sample.

Product Code /Description	Pack Qty	← White →		Woodgrains					Premiergrain				Colours →		
		Brilliant White BW	Mahogany WG	Blackgrain BG	Sherwood SG	Rosewood PG	Whitegrain WHG	Creamgrain CRG	Irish Oak IOG	Anthracite Grey AGG	Sand 1015	Light Grey 7035	Brown B		
<b>691</b> HSection for 603, 803, 903 and Hollow Soffit	5 x 5m	✓	✓	✓	✓	✓				✓			✓		
<b>6915</b> HSection	5 x 5m	✓													
<b>692</b> Soffit Channel for 603, 803, 903, 690/300 and Hollow Soffit	5 x 5m	✓													
<b>662/525</b> Soffit Vent Trim (25mm air gap)	10 x 5m	✓									✓	✓	✓		
<b>699</b> Flat Roof Edge Trim x 9mm	10 x 5m	✓													
<b>661/075</b> Fixing Chanel x 9mm	10 x 5m	✓	✓	✓	✓	✓	✓*	✓	✓	✓	✓	✓	✓		
<b>693</b> Panel Joint Trim	5 x 5m	✓	✓	✓	✓	✓	✓*	✓	✓	✓	✓	✓			

\* **Made To Order** Up to three week lead time. Minimum order quantity may apply.

# Dry Verge

**NEW**

## Verge Master



DVLH and DVRH



DVLHS and DVRHS

## Verge Wizard



DVU

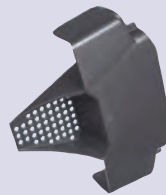

DVUS

## Verge Top Ridge Caps



DVRCR

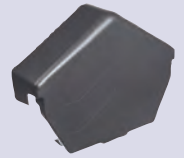

DVRCA

## Dry Verge Fixings



DVBEC

Available in the following colours:



Grey    Brown    Black    Stainless Steel  
**GR**    **BR**    **BL**    **S/Steel**

Product Code	Description	Pack Qty	Colours			
			Grey GR	Brown BR	Black BL	Stainless Steel S/Steel

### VERGE MASTER

#### Verge Master - Premium Dry Verge System

Product Code	Description	Pack Qty	Grey	Brown	Black	Stainless Steel
DVLH-50	Verge Master Dry Verge Left	50	✓	✓	✓	
DVRH-50	Verge Master Dry Verge Right	50	✓	✓	✓	
DVLHS-30	Verge Master Dry Verge Left Starter	30	✓	✓	✓	
DVRHS-30	Verge Master Dry Verge Right Starter	30	✓	✓	✓	

### VERGE WIZARD

#### Verge Wizard - Premium Dry Verge System

Product Code	Description	Pack Qty	Grey	Brown	Black	Stainless Steel
DVU-60	Verge Wizard Dry Verge Universal	60	✓	✓		
DVUS-30	Verge Wizard Dry Verge Universal Starter	30	✓	✓		

#### Verge Top Ridge Caps

Product Code	Description	Pack Qty	Grey	Brown	Black	Stainless Steel
DVRCR-10	Dry Verge Ridge Cap Round	10	✓	✓	✓	
DVRCA-10	Dry Verge Ridge Cap Angled	10	✓	✓	✓	

#### Dry Verge Fixings

Product Code	Description	Pack Qty	Grey	Brown	Black	Stainless Steel
DVBEC50	Verge Master Dry Verge Batten End Clips	50				✓

# Kayguard

Eaves Products, Ventilation and Eaves Protection Systems



KAYGUARD

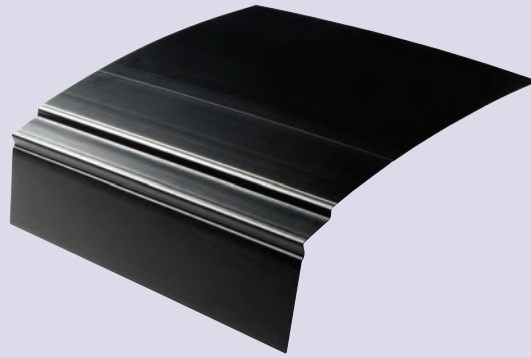

K708

Available in the following colour:



Black

No Ref

Whites: Finish will vary from catalogue, please request a sample.

Product Code	Description	← Colours →	
		Pack Qty	Black No Ref
<b>KAYGUARD</b>	Gutter Brush System (3m)	5 x 3m	✓
<b>K708/150</b>	K.Shield 263mm Eaves Protection System (1.5m)	15 x 1.5m	✓

# Eaves Protection

Eaves Products, Ventilation and Eaves Protection Systems



Available in the following colours:



White

Black

W

No Ref

Whites: Finish will vary from catalogue, please request a sample.

Product Code	Description	← White →		← Colours →	
		Pack Qty	White W	Pack Qty	Black No Ref
UNIOFV	Over Fascia Vent and Eaves Protector 2m x 10mm Venting			6 x 2m	✓
K712/1000	K Shield Over Fascia Ventilation Strip (10mm air gap)			25 x 1m	✓
K712/025	K.Shield Over Fascia Ventilation Strip (25mm air gap)			5 x 1m	✓
K713	K.Shield Bird Comb Filler			50 x 1m	✓
K716	Circular Soffit Vent	50	✓		

# 704/ Hockey Window - Fascia Capping Boards x 9mm

→ 9mm hockey windowboard with a 34mm bullnose

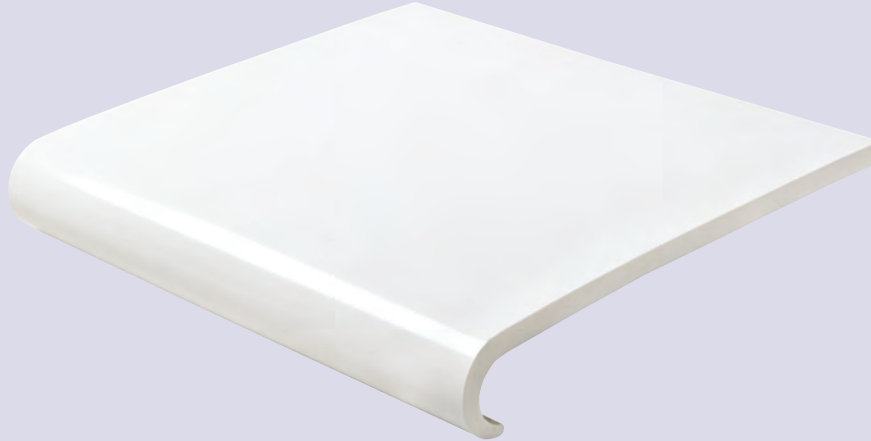

704/200

Available in the following colours:



Brilliant  
White  
**BW**



Mahogany  
**WG**



Blackgrain  
**BG**



Sherwood  
**SG**



Rosewood  
**PG**



White  
grain  
**WHG**



Cream  
grain  
**CRG**



Irish Oak  
**IOG**

Whites: Finish will vary from catalogue, please request a sample.

Product Code	Description	White		Woodgrains					Premiergrain		
		Pack Qty	Brilliant White BW	Pack Qty	Mahogany WG	Blackgrain BG	Sherwood SG	Rosewood PG	Whitegrain WHG	Creamgrain CRG	Irish Oak IOG
704/150	150mm x 9mm	2 x 5m	✓								
704/175	175mm x 9mm	2 x 5m	✓	2 x 5m	✓		✓	✓			
704/200	200mm x 9mm	2 x 5m	✓	2 x 5m	✓*	✓	✓	✓	✓	✓	
704/225	225mm x 9mm	2 x 5m	✓	2 x 5m	✓		✓	✓	✓		✓
704/250	250mm x 9mm	2 x 5m	✓	2 x 5m			✓				
704/300	300mm x 9mm			2 x 5m					✓		✓*
704/405	405mm x 9mm	1 x 5m	✓	1 x 5m	✓*	✓*	✓	✓			

\* Made To Order Up to three week lead time. Minimum order quantity may apply.

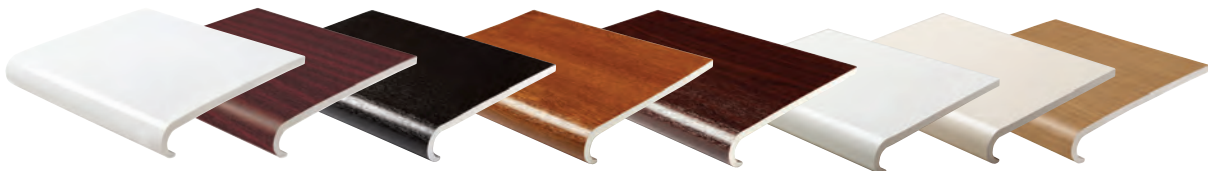

# 704/ Accessories - Hockey Window x 9mm



Windowline

Available in the following colours:

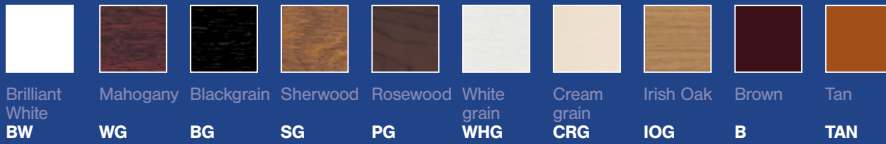

Whites: Finish will vary from catalogue, please request a sample.

Product Code /Description	Pack Qty	White		Woodgrains				Premiergrain			Colours		
		Brilliant White BW	Pack Qty	Mahogany WG	Blackgrain BG	Sherwood SG	Rosewood PG	Whitegrain WHG	Creamgrain CRG	Irish Oak IOG	Pack Qty	Brown B	Tan TAN
<b>748/300</b> 300mm x 46mm External Cover Joint	10	✓											
<b>749/300</b> 300mm x 40mm Cover Joint	10	✓											
<b>753/053</b> 53mm End Cap	50 Pairs	✓									50 Pairs	✓	✓
<b>753/300</b> 300mm End Cap	10 Pairs	✓	5 Pairs	✓	✓	✓	✓	✓	✓	✓	10 Pairs	✓	✓
<b>652/010</b> Window Board Channel x 9mm For 704 and 604 Range	20 x 5m	✓											
<b>652/115</b> Plasterboard Channel x 11.5mm	20 x 5m	✓											

\* **Made To Order** Up to three week lead time. Minimum order quantity may apply.

## 604/ Bullnosed Window - Fascia Capping Boards x 9mm

→ 9mm bullnose windowboard with a 36mm bullnose

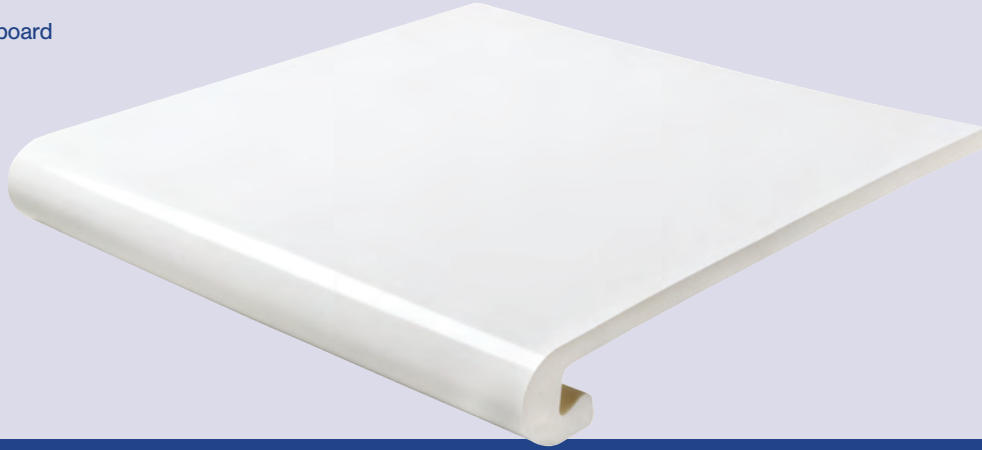

604/125

Available in the following colour:



Brilliant  
White  
**BW**

Whites: Finish will vary from catalogue, please request a sample.

← White →

Product Code	Description	Pack Qty	Brilliant White BW
604/125	155mm x 9mm	2 x 5m	✓
604/175	205mm x 9mm	2 x 5m	✓
604/200	230mm x 9mm	2 x 5m	✓
604/225	255mm x 9mm	2 x 5m	✓
604/275	305mm x 9mm	2 x 5m	✓
604/405	470mm x 9mm (Double End)	1 x 5m	✓



## 604/Accessories - Bullnosed Window x 9mm



Windowline

Available in the following colour:



Brilliant  
White  
**BW**

Whites: Finish will vary from catalogue, please request a sample.

Product Code	Description	White	
		Pack Qty	Brilliant White BW
653/032	32mm End Cap for 604	50 Pairs	✓
653/300	300mm End Cap for 604	10 Pairs	✓
656/250	250mm x 40mm Cover Joint for 604	10	✓
659/250	250mm x 60mm Ext. Corner Joint for 604	10	✓
652/504	Channel Windowboard x 10mm	25 x 5m	✓

# Laminated Windowboards/ 22mm Bullnose

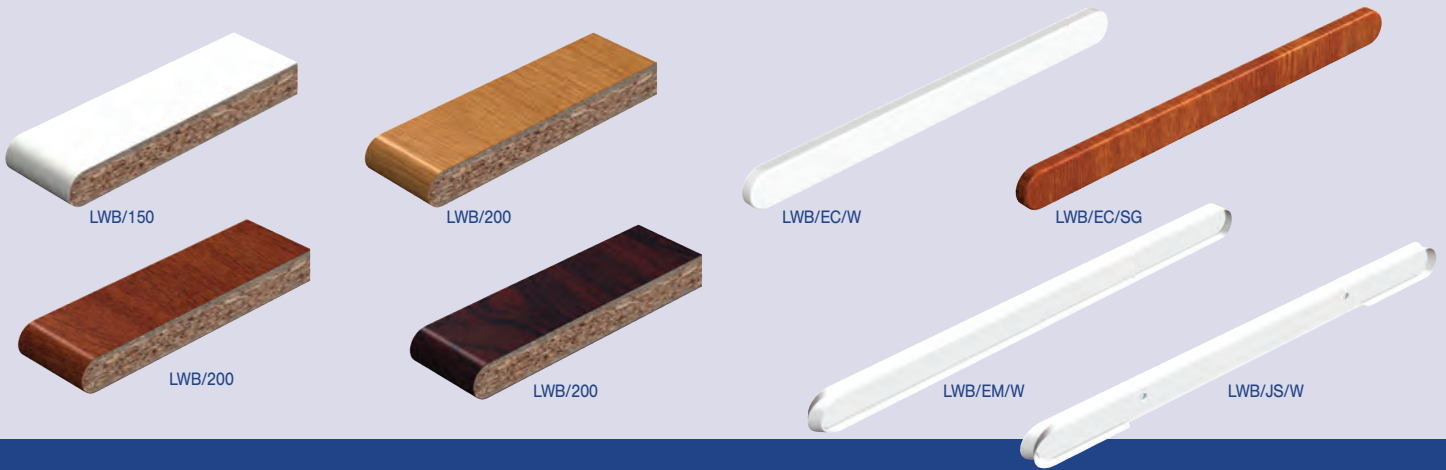

Available in the following colours:

			
White	Sherwood	Rosewood	Irish Oak
<b>W</b>	<b>SG</b>	<b>PG</b>	<b>IOG</b>

Whites: Finish will vary from catalogue, please request a sample.

Product Code	Description	Pack Qty	White		Woodgrains			Premiergrain
			White W	Pack Qty	Sherwood SG	Rosewood PG	Irish Oak IOG	
LWB/150	150mm Windowboard 5m	1 x 5m	✓					
LWB/200	200mm Windowboard 5m	1 x 5m	✓	1 x 5m	✓	✓	✓	
LWB/225	225mm Windowboard 5m	1 x 5m	✓	1 x 5m	✓	✓	✓	
LWB/250	250mm Windowboard 5m	1 x 5m	✓	1 x 5m	✓	✓	✓	
LWB/300	300mm Windowboard 5m	1 x 5m	✓	1 x 5m	✓	✓	✓	
LWB/600/3.0	600mm Windowboard 3m	1 x 3m	✓	1 x 3m	✓	✓	✓	
LWB/600/4.1	600mm Windowboard 4.1m	1 x 4.1m	✓	1 x 4.1m	✓	✓		

### Accessories - Laminated Windowboards

Product Code	Description	Pack Qty	White	Woodgrains	Premiergrain
LWB/EC	300mm End Cap	50 ea	✓	✓	✓
LWB/EM	400mm External Mitre	50 ea	✓	✓	✓
LWB/JS	375mm Joint Strip	50 ea	✓	✓	✓

# Flat Back/ Architraves x 5.5mm



712/045



712/065

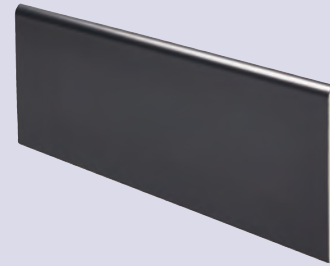

712/095

Available in the following colours:



Whites: Finish will vary from catalogue, please request a sample.

Product Code	Description	Pack Qty	← White →	← Woodgrains →					← Premiergrain →				← Smoothgrain →		
			Brilliant White BW	Pack Qty	Mahogany WG	Blackgrain BG	Sherwood SG	Rosewood PG	Whitegrain WHG	Creamgrain CRG	Irish Oak IOG	Anthracite Grey AGG	Anthracite Smooth Grey ASG	Smooth Slate Grey SSG	
712/045	45mm x 5.5mm: Flat Back	10 x 5m	✓	4 x 5m	✓	✓	✓	✓	✓	✓	✓	✓	✓	✓	✓
712/065	65mm x 5.5mm: Flat Back	10 x 5m	✓	4 x 5m	✓	✓	✓	✓	✓	✓	✓	✓	✓	✓	✓
712/095	95mm x 5.5mm: Flat Back	10 x 5m	✓	4 x 5m	✓	✓	✓	✓	✓	✓	✓	✓	✓	✓	✓

# Ridge Back/Architraves x 7mm

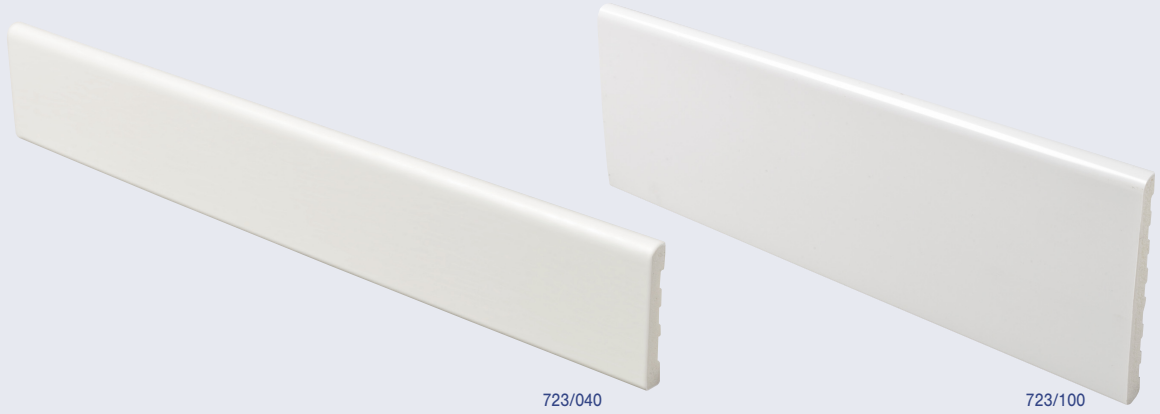

723/040

723/100

Available in the following colour:



Brilliant  
White  
**BW**

Whites: Finish will vary from catalogue, please request a sample.

Product Code	Description	White	
		Pack Qty	Brilliant White BW
723/040	40mm x 7mm: Ridge Back Pencil Round	10 x 5m	✓
723/060	60mm x 7mm: Ridge Back Pencil Round	10 x 5m	✓
723/100	100mm x 7mm: Ridge Back Pencil Round	10 x 5m	✓

# Ogee/Architraves x 18mm



Available in the following colours:

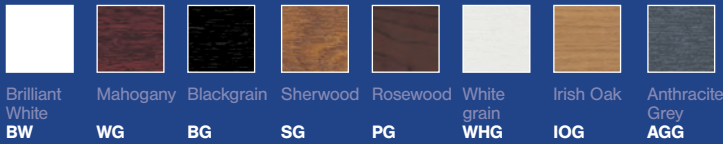

Whites: Finish will vary from catalogue, please request a sample.

Product Code	Description	Pack Qty	White	Woodgrains				Premiergrain			
			Brilliant White BW	Mahogany WG	Blackgrain BG	Sherwood SG	Rosewood PG	Whitegrain WHG	Irish Oak IOG	Anthracite Grey AGG	
733/070/5.3	70mm x 18mm Ogee 5.3m Long	5 x 5.3m	✓	✓*	✓	✓	✓	✓	✓*	✓*	✓
733/125	125mm x 18mm Ogee	5 x 5m	✓	✓	✓	✓	✓	✓	✓	✓	✓

\* Made To Order Up to three week lead time. Minimum order quantity may apply.



733/125/BW      733/125/WG      733/125/BG      733/125/SG      733/125/IOG      733/125/AGG

# Cover Cills/ PVC-U Cover Cills & End Caps

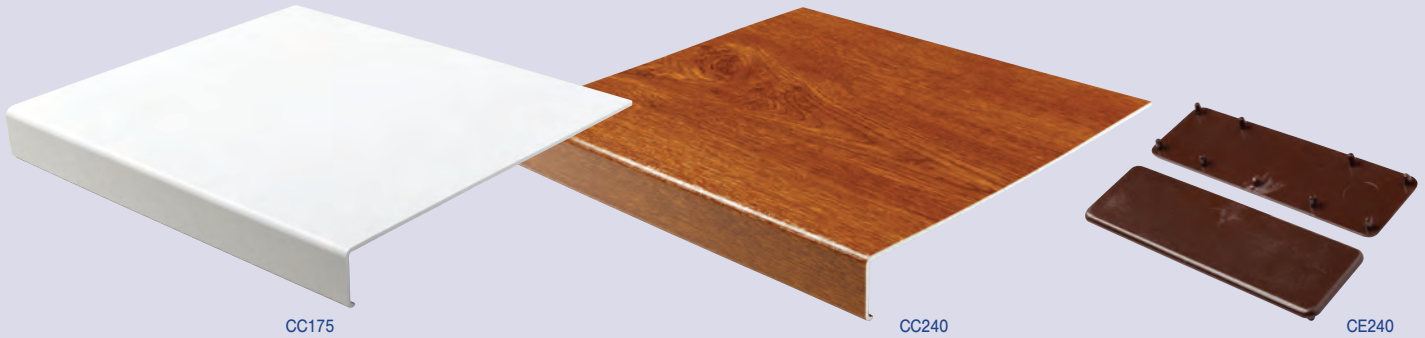

Whites: Finish will vary from catalogue, please request a sample.

Product Code	Description	White		Woodgrains			Colours		
		Pack Qty	Brilliant White BW	Pack Qty	Mahogany WG	Sherwood SG	Pack Qty	Brown B	Tan TAN
CC175	175mm Cover Cill	5 x 5m	✓						
CC240	240mm Cover Cill	5 x 5m	✓	5 x 5m	✓	✓*			
CE240	100mm End Cap for CC175 & CC240	50 Pairs	✓				50 Pairs	✓	✓

\* Made To Order Up to three week lead time. Minimum order quantity may apply.

# Trims/Window Finishing Trims

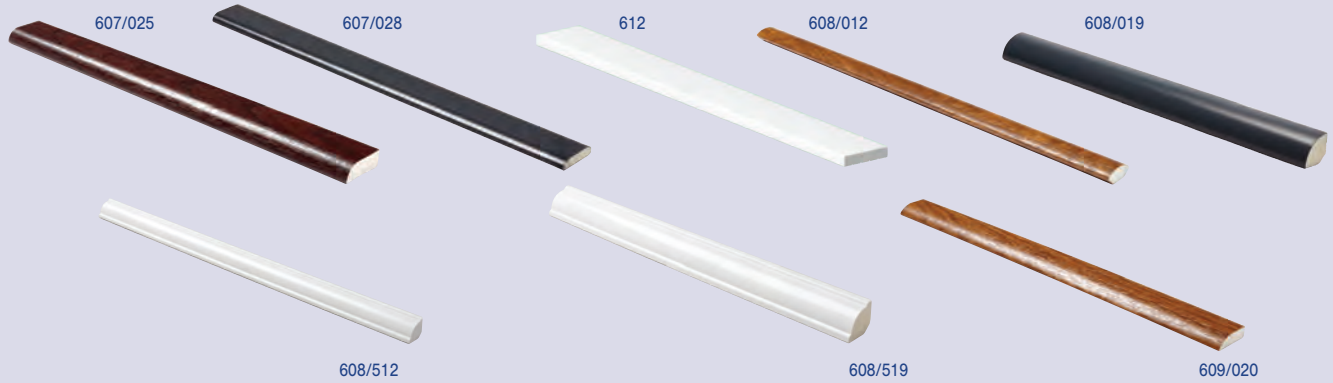

Available in the following colours:



Whites: Finish will vary from catalogue, please request a sample.

Product Code	Description	Pack Qty	← White → Woodgrains → Premiergrain → Smoothgrain →											
			Brilliant White BW	Mahogany WG	Blackgrain BG	Sherwood SG	Rosewood PG	Whitegrain WHG	Creamgrain CRG	Irish Oak IOG	Anthracite Grey AGG	Anthracite Smooth Grey ASG	Slate Smooth Grey SSG	
607/025	25mm x 9mm Pencil Round Fillet	25 x 5m 10 x 5m	✓				✓							
607/028	28mm x 6mm D Section	25 x 5m 10 x 5m	✓	✓	✓	✓	✓	✓	✓	✓	✓	✓	✓	NEW ✓
612	28mm x 6mm Rectangle	20 x 5m	✓											
608/012	12mm Quadrant	25 x 5m 10 x 5m	✓	✓	✓	✓	✓	✓	✓					
608/019	18mm Quadrant	25 x 5m 10 x 5m	✓	✓	✓	✓	✓	✓	✓	✓	✓	✓	✓	NEW ✓
608/512	12mm Ogee Quadrant	40 x 5m	✓											
608/519	18mm Ogee Quadrant	20 x 5m	✓											
609/020	20mm x 6mm Edge Fillet	25 x 5m 10 x 5m	✓	✓	✓	✓	✓				✓			

# Trims/Window Finishing Trims

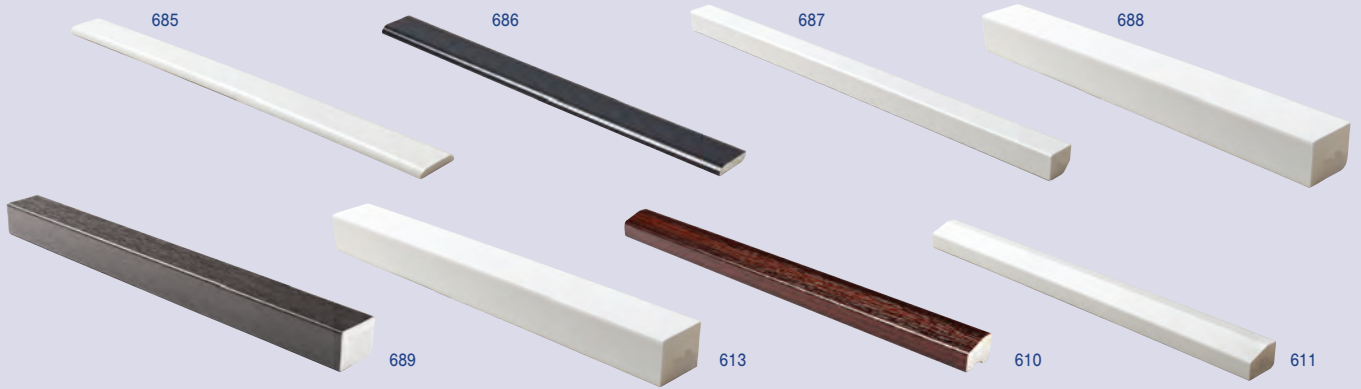

Available in the following colours:



Whites: Finish will vary from catalogue, please request a sample.

Product Code	Description	Pack Qty	← White → Woodgrains → Premiergrain → Smoothgrain →													
			Brilliant White BW	Mahogany WG	Blackgrain BG	Sherwood SG	Rosewood PG	Whitegrain WHG	Creamgrain CRG	Irish Oak IOG	Anthracite Grey AGG	Anthracite Smooth Grey ASG	Slate Smooth Grey SSG			
685	25mm x 4mm D Section	25 x 5m 10 x 5m	✓			✓	✓									
686	28mm x 6mm Edge Fillet	25 x 5m 10 x 5m	✓	✓	✓	✓	✓	✓	✓	✓	✓	✓	NEW ✓			
687	15mm x 13mm Rectangle	20 x 5m 5 x 5m	✓	✓	✓	✓	✓				✓					
688	25mm x 30mm Rectangle	10 x 5m	✓													
689	25mm x 20mm Rectangle	10 x 5m 5 x 5m	✓	✓	✓	✓	✓				✓					
613	19mm x 19mm Square Trim	10 x 5m	✓													
610	20mm x 15mm Unitrim	20 x 5m 20 x 5m	✓	✓*		✓	✓			✓	✓					
611	20mm x 15mm Varitrim	20 x 5m	✓													

\* Made To Order Up to three week lead time. Minimum order quantity may apply.



# Trims/Window Finishing Trims

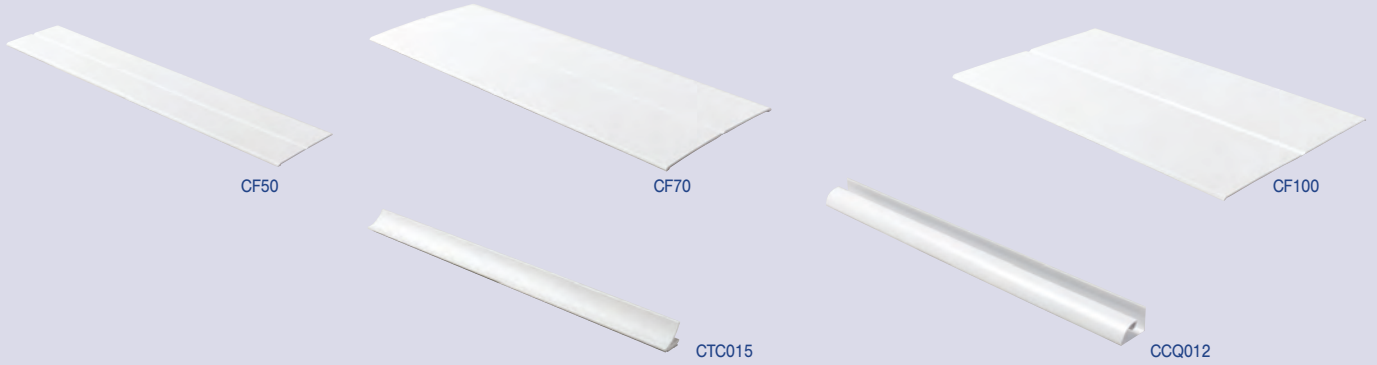

Available in the following colours:

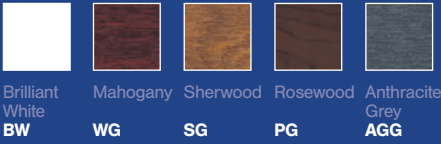

Whites: Finish will vary from catalogue, please request a sample.

Product Code	Description	White		Woodgrains			Premiergrain
		Pack Qty	Brilliant White BW	Pack Qty	Mahogany WG	Sherwood SG	Rosewood PG
CF50	25mm x 25mm Flexible Angle	10 x 5m	✓	10 x 5m	✓*	✓	✓
CF70	35mm x 35mm Flexible Angle	20 x 5m	✓				
CF100	50mm x 50mm Flexible Angle	10 x 5m	✓	10 x 5m	✓	✓	✓*
CF150	75mm x 75mm Flexible Angle	5 x 5m	✓				
CTC015	Scotia Self Adhesive 13mm	25 x 5m	✓				
CCQ012	Quadrant Clip 22 x 16mm	25 x 5m	✓				

NB: All woodgrain flexible angles are foiled Pre-Bent

\* Made To Order Up to three week lead time. Minimum order quantity may apply.

## Angles/Rigid Angles



Available in the following colours:

Brilliant  
White  
**BW**Mahogany  
**WG**Sherwood  
**SG**Rosewood  
**PG**

Whites: Finish will vary from catalogue, please request a sample.

Product Code	Description	Pack Qty	White		Woodgrains			
			Brilliant White BW	Pack Qty	Mahogany WG	Sherwood SG	Rosewood PG	
CA180	100mm x 80mm Rigid Angle	5 x 5m	✓	5 x 5m	✓	✓	✓	
KB1023	100mm (2mm) x 100mm (3mm) Rigid Angle	5 x 6m	✓					
KB2525	25mm x 25mm (2mm) Rigid Angle	10 x 6m	✓					
KB423	40mm (2mm) x 30mm (3mm) Rigid Angle	10 x 6m	✓					
KB523	50mm (2mm) x 40mm (3mm) Rigid Angle	10 x 6m	✓					
KB623	60mm (2mm) x 40mm (3mm) Rigid Angle	10 x 6m	✓					
KA2525	25mm x 25mm x 1.3mm Rigid Angle	10 x 5m	✓					
KA3232	32mm x 32mm x 1.3mm Rigid Angle	10 x 5m	✓					
KA4040	40mm x 40mm x 1.3mm Rigid Angle	10 x 5m	✓					
KA5050	50mm x 50mm x 1.3mm Rigid Angle	10 x 5m	✓					

# Vented Cladding/871 Series



871/100

Available in the following colour:



Brilliant  
White  
**BW**

Whites: Finish will vary from catalogue, please request a sample.

Product Code	Description	White	
		Pack Qty	Brilliant White <b>BW</b>
<b>871/100</b>	100mm Open V Joint Vented Cladding (12.5mm air gap)	5 x 5m	✓

# Cladding/ 670 and 671 Series



670/150

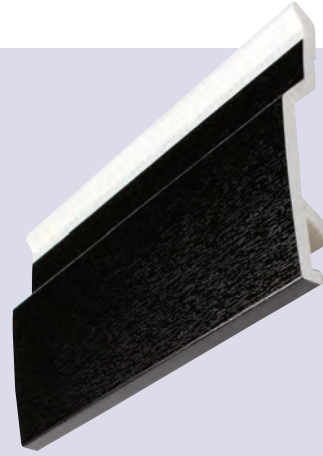

671/100

Available in the following colours:



Brilliant White  
**BW**



Mahogany  
**WG**



Blackgrain  
**BG**



Sherwood  
**SG**



Rosewood  
**PG**



Anthracite Grey  
**AGG**

Whites: Finish will vary from catalogue, please request a sample.

Product Code	Description	Pack Qty	White		Woodgrains				Premiergrain
			Brilliant White BW	Pack Qty	Mahogany WG	Blackgrain BG	Sherwood SG	Rosewood PG	Anthracite Grey AGG
670/150	150mm Shiplap Cladding	5 x 5m	✓	5 x 5m	✓	✓	✓	✓	✓
670/150/6.0	150mm Shiplap Cladding 6 metre	5 x 6m	✓						
671/100	100mm Open V Joint Cladding	5 x 5m	✓	5 x 5m	✓	✓	✓	✓	✓

Please note that 670 and 671 ranges can be used as interlocking soffit boards

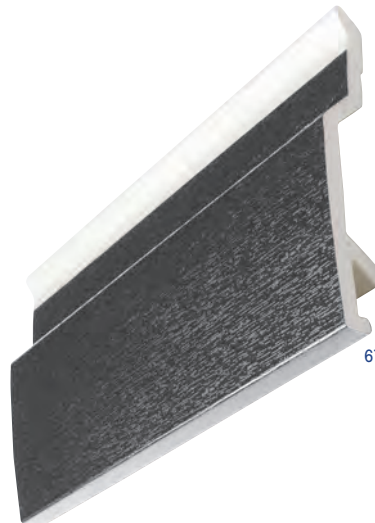

671/100/AGG

# Cladding/ Accessories - 670 and 671 Range

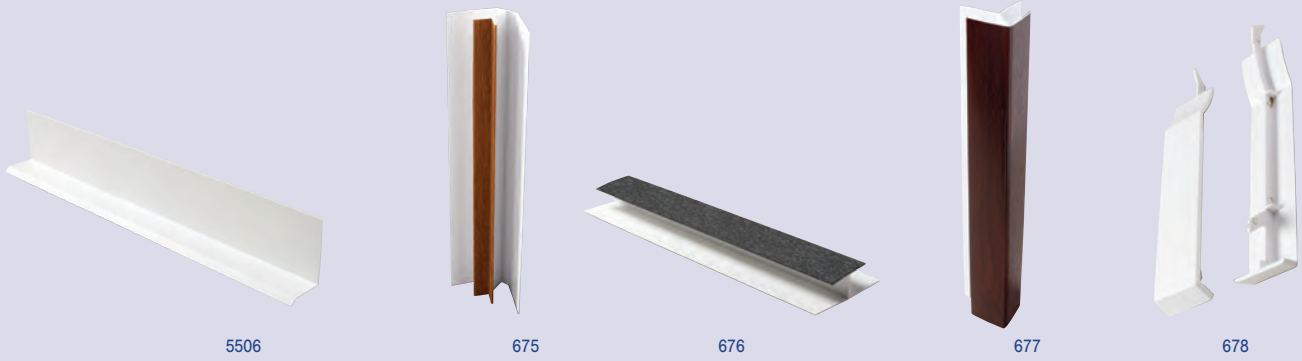

Available in the following colours:

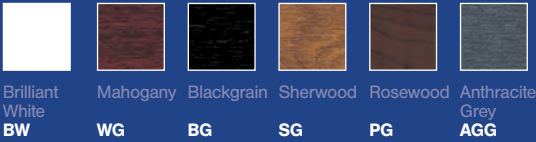

Whites: Finish will vary from catalogue, please request a sample.

Product Code	Description	White		Woodgrains					Premiergrain
		Pack Qty	Brilliant White BW	Pack Qty	Mahogany WG	Blackgrain BG	Sherwood SG	Rosewood PG	Anthracite Grey AGG
5506	Drip Trim	10 x 5m	✓						
675	Internal Corner Trim	5 x 5m	✓	2 x 5m	✓*	✓*	✓*	✓*	
676	Cover Joint Trim	5 x 5m	✓	2 x 5m	✓	✓	✓	✓	✓* <small>NEW</small>
677	External Corner Trim	5 x 5m	✓	2 x 5m	✓	✓	✓	✓	
678	150mm Shiplap Cover Joint	50 ea	✓						

\* Made To Order Up to three week lead time. Minimum order quantity may apply.

Please note that 670 and 671 ranges can be used as interlocking soffit boards

# Cladding/Accessories - 670 and 671 Range



Available in the following colours:

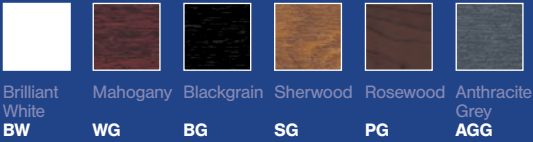

Whites: Finish will vary from catalogue, please request a sample.

Product Code	Description	White		Woodgrains					Premiergrain	Colours	
		Pack Qty	Brilliant White <b>BW</b>	Pack Qty	Mahogany <b>WG</b>	Blackgrain <b>BG</b>	Sherwood <b>SG</b>	Rosewood <b>PG</b>	Anthracite Grey <b>AGG</b>	Pack Qty	Brown <b>B</b>
679	100mm Open V Cover Joint	50 ea	✓								
680	Two Part Corner Trim	5 x 5m	✓	2 x 5m	✓	✓	✓	✓	✓		
681	Two Part Universal Trim	5 x 5m	✓	2 x 5m	✓	✓	✓	✓	✓		
682	Universal Channel	10 x 5m	✓	2 x 5m	✓	✓	✓	✓	✓		
683	Starter trim with Batten Cover	5 x 5m	✓							5 x 5m	✓

Please note that 670 and 671 ranges can be used as interlocking soffit boards

# Kavex Range/ Textured Cladding



DCE/150



DCE/300

Available in the following colours:



White	Sand	Cream	Light Grey	Light Blue
<b>W</b>	<b>1015</b>	<b>9001</b>	<b>7035</b>	<b>X002</b>

Whites: Finish will vary from catalogue, please request a sample.

Product Code	Description	Pack Qty	Available in following colours				
			White <b>W</b>	Sand <b>1015</b>	Cream <b>9001</b>	Light Grey <b>7035</b>	Light Blue <b>X002</b>
<b>DCE/150</b>	150mm Textured Shiplap Cladding	5 x 5m	✓*	✓*	✓*		
<b>DCE/300</b>	300mm Double Textured Shiplap Cladding	4 x 5m	✓	✓	✓	✓	✓

\* **Made To Order** Up to three week lead time. Minimum order quantity may apply.



# Kavex Range/Textured Cladding

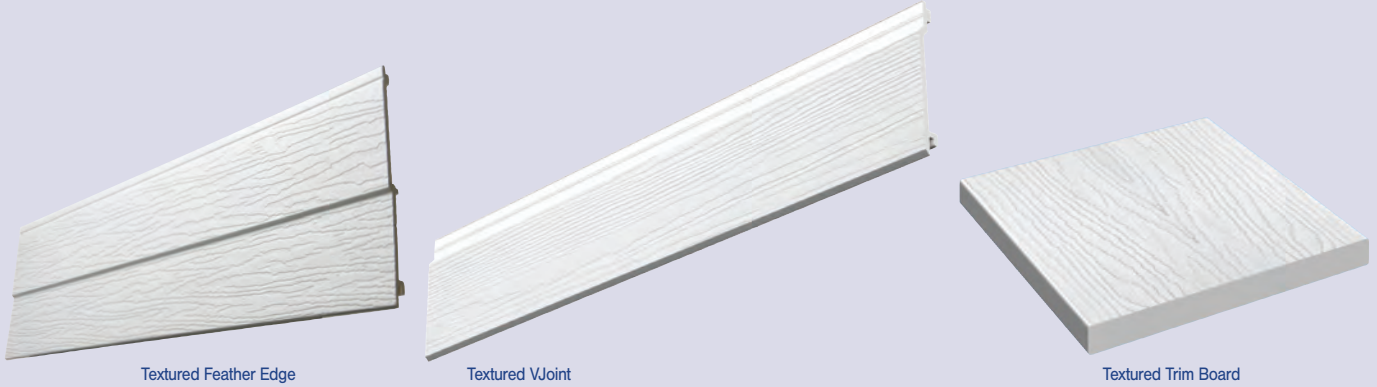

Available in the following colours:



Whites: Finish will vary from catalogue, please request a sample.

Product Code	Description	Pack Qty	Available in following colours				
			White <b>W</b>	Sand <b>1015</b>	Cream <b>9001</b>	Light Grey <b>7035</b>	Light Blue <b>X002</b>
<b>DFE/270</b>	270mm Double Textured Feather Edge Cladding	4 x 5m	✓*	✓*	✓*	✓*	✓*
<b>SVE/150</b>	150mm Textured V Joint Cladding	5 x 5m	✓*	✓*	✓*	✓*	✓*
<b>TEXTRIM/100</b>	100mm x 9mm Textured Trim	5 x 5m	✓*				

\* **Made To Order** Up to three week lead time. Minimum order quantity may apply.





# Kavex Range/Accessories - Textured Cladding

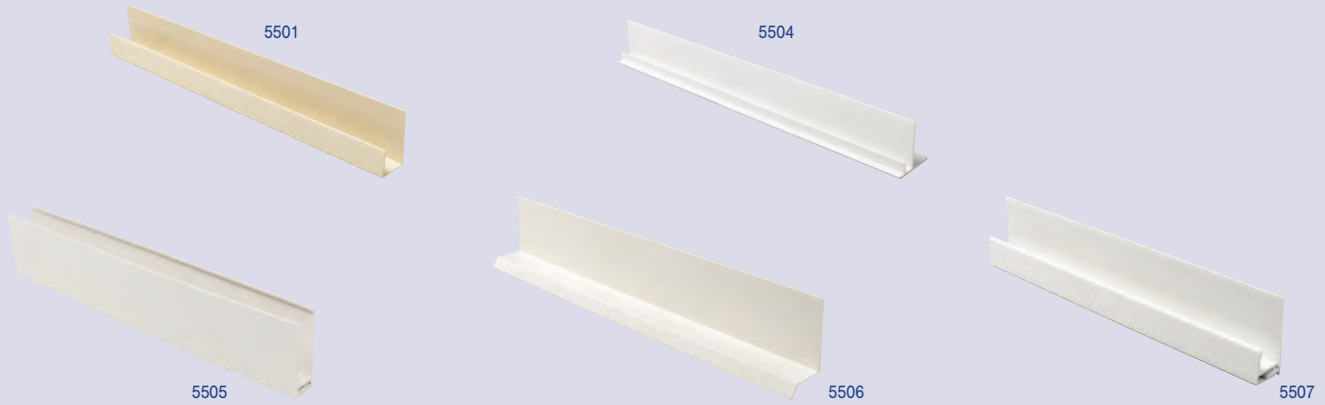

Available in the following colours:



Whites: Finish will vary from catalogue, please request a sample.

Product Code	Description	Pack Qty	Available in following colours				
			White W	Sand 1015	Cream 9001	Light Grey 7035	Light Blue X002
5501	Universal Channel for Kavex Cladding	10 x 5m	✓	✓	✓	✓	✓
5504	Starter Trim with Batten Cover for Kavex Cladding	10 x 5m	✓	✓			✓
5505	2 Part Top Edge Trim for Kavex Cladding	5 x 5m	✓	✓	✓	✓	✓
5506	Drip Trim	10 x 5m	✓	✓	✓		
5507	2 Part Universal Trim for Kavex Cladding	5 x 5m	✓				

# Kavex Range/Accessories - Textured Cladding



Available in the following colours:



White

Sand

Cream

Light Grey

Light Blue

**W****1015****9001****7035****X002**

Whites: Finish will vary from catalogue, please request a sample.

Available in following colours

Product Code	Description	Pack Qty	White	Sand	Cream	Light Grey	Light Blue
			<b>W</b>	<b>1015</b>	<b>9001</b>	<b>7035</b>	<b>X002</b>
<b>5513</b>	2 Part Int/Ext Corner Trim (50mm) for Kavex Cladding	5 x 5m	✓	✓	✓	✓	✓
<b>5509</b>	2 Part Centre Joint Trim for Kavex Cladding	5 x 5m	✓	✓	✓	✓	✓
<b>5510</b>	Wall Starter Trim for Kavex Cladding	10 x 5m	✓	✓	✓	✓	✓
<b>5512</b>	150mm plain Shiplap Cover Joint for Kavex Cladding	20	✓	✓	✓		
<b>5516</b>	Universal Trim With Edge Cover for Kavex Cladding	5 x 5m	✓				
<b>DCE/JNT2</b>	300mm Textured Cover Joint for DCE/300	10	✓	✓	✓	✓	✓
<b>DFE/JNT2</b>	270mm Textured Cover Joint for DFE/270	10	✓	✓	✓	✓	✓

# Fixings/Nails and Pins

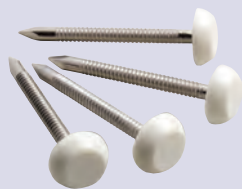

SS40N



SS40P



SS30CP

Available in the following colours:

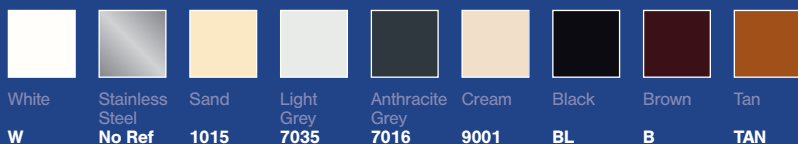

Whites: Finish will vary from catalogue, please request a sample.

Product Code /Description	White			Colours							
	Pack Qty	White W	Stainless Steel No Ref	Pack Qty	Sand 1015	Light Grey 7035	Anthracite Grey 7016*	Cream 9001	Black BL	Brown B	Tan TAN
<b>SS-65N</b> 65mm Plastic Headed Nail 10G	100pb	✓		100pb	✓	✓	✓	✓	✓	✓	✓
<b>SS-50N</b> 50mm Plastic Headed Nail 10G	100pb	✓		100pb	✓	✓	✓		✓	✓	✓
<b>SS-40N</b> 40mm Plastic Headed Nail 10G	100pb	✓									
<b>SS-40P</b> 40mm Plastic Headed Pin 14G	250pb	✓		250pb	✓	✓	✓	✓	✓	✓	✓
<b>SS-30P</b> 30mm Plastic Headed Pin 14G	250pb	✓									
<b>SS-30-CP</b> 30mm Cladding Pin 14G	250pb		✓								

\* RAL 7016 nails to be used with Anthracite Grey (AGG) foils

# Colour Swatch



## Whites

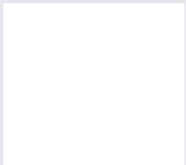

Brilliant White - BW

Whites: Finish will vary from catalogue, please request sample

## Solid Colours

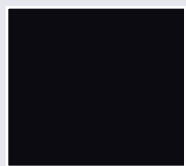

Black - BL



Sand - 1015

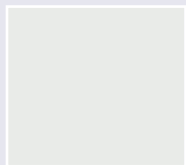

Light Grey - 7035



Cream - 9001

## Kavex Range

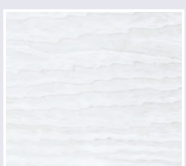

White - W



Light Grey - 7035

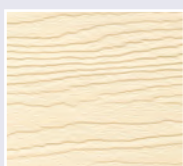

Sand - 1015

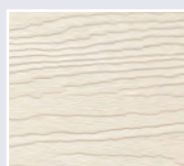

Cream - 9001



Light Blue - X002

## Premiergrains\*



Whitegrain - WHG

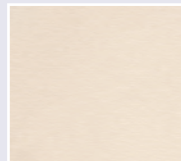

Creamgrain - CRG

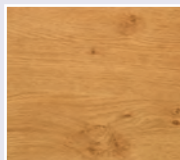

Irish Oak - IOG

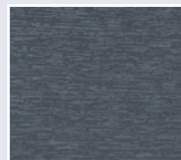

Anthracite Grey - AGG

\*Up to three week lead time

## Smoothgrain

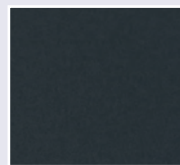

Anthracite Smooth Grey - ASG

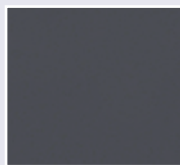

Slate Smooth Grey - SSG

## Woodgrains

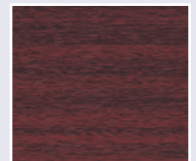

Mahogany - WG

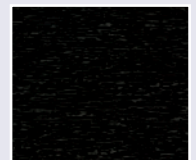

Blackgrain - BG

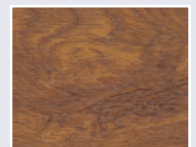

Sherwood - SG

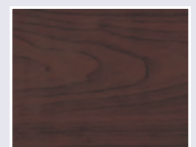

Rosewood - PG

Please call customer services on 08702 406107 for a colour swatch.

Decking and balustrade system



NEW



**DEKBOARD<sup>®</sup>**

The Range Guide

Extend your outdoor living space with our stylish, practical PVC decking & balustrade system

dekboard.co.uk

Decking

## DEKBOARD

With DekBoard, you can create a clean, safe and secure outdoor living area for rest, play and getting together.

The DekBoard system is made from fully recyclable PVC, manufactured in the UK and allows you to extend your home seamlessly into a beautiful outdoor living space.

Ideal for garden and patio areas, DekBoard is made to look and feel like high-quality timber, without the need for the time consuming and costly maintenance that timber always needs.

Our stylish decking system will increase the usable area in and around your home, allowing you to enjoy the outdoors. and still feel safe, clean and in control of your own space.

### DEKBOARD CONTENTS

Decking	56-57
Balustrade	58-64
Post	58-59
Handrails	60-61
Pickets	62
Brackets	63
Gates	64
Maintenance and Aftercare	65
Project Planner	66-67
Reversible Composite Decking	69-70
Fiberon Sanctuary	71-72
Fiberon Good Life	73-74

All instructions and suggestions in this document are given for guidance only and the installer should satisfy themselves that their planned deck will be safe given their individual circumstances and requirements.

Warranty available upon request. Please contact us for more details.

## The DekBoard System

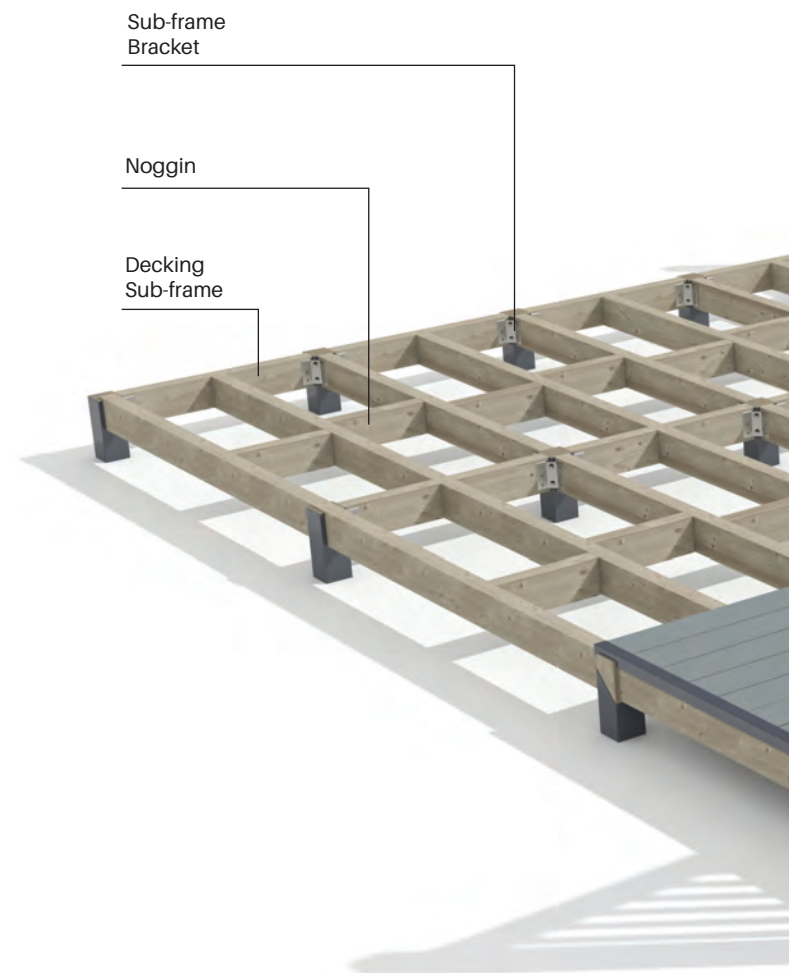



Transform your home's outdoor living space with a bespoke design to meet your needs



### Installation

Care should be taken when working in extreme windy and wet conditions. All Installations should take place at ambient temperatures between 5° C and 25° C.

Solvent adhesive or Superglues must never come into contact / used with foil surfaces. All products must be stored out of direct sunlight.

**Note:** Glass screens are known to intensify the effects of sunlight on plastic packaged items.



Robust



Slip Resistant



Low Maintenance



100% Recyclable



Long Life



Product Testing

## DEKBOARD

A great range of practical PVC decking boards with a stylish, traditional woodgrain effect pattern.

Our boards are designed to be tough and durable, allowing you to enjoy your garden with confidence.

The board's satin finish is embossed for good slip resistance and the surface is easy to clean, giving you a stress free, low maintenance outdoor area to enjoy.

DekBoard has a great range of contemporary and neutral colours that go well with any settings and truly complement our balustrade range.



Light Oak

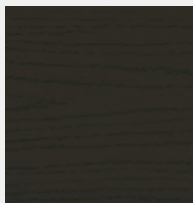

Dark Oak

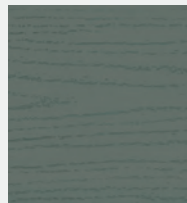

Moss grey

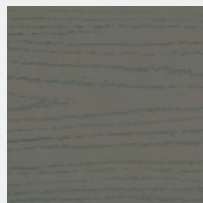

Driftwood

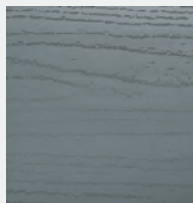

Luna grey



Anthracite Grey

## Decking

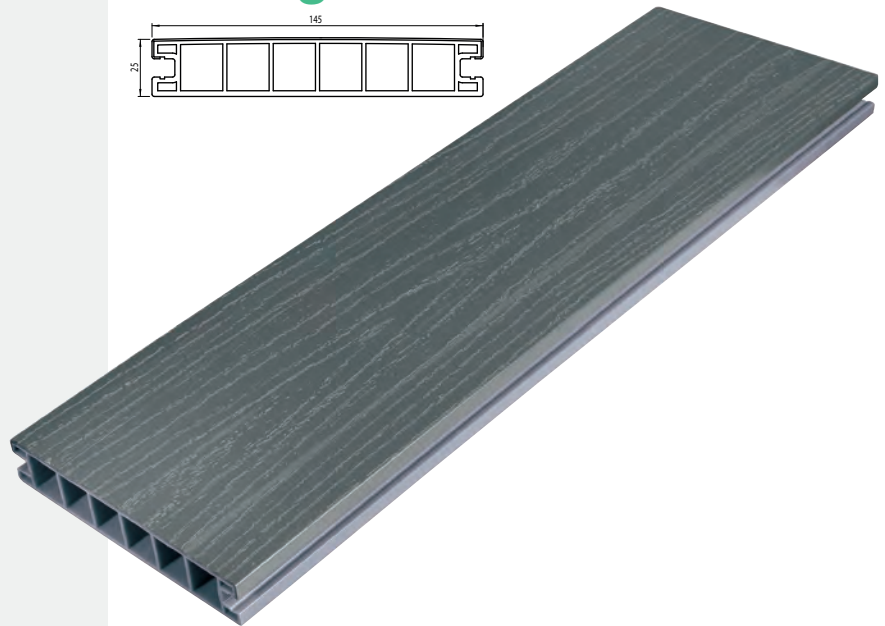
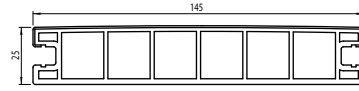

Code	Colour	Length (m)
DDBP4902LO	Light Oak	4.902
DDBP4902DO	Dark Oak	4.902
DDBP4902MG	Moss Grey	4.902
DDBP4902DW	Driftwood	4.902
DDBP4902LN	Luna Grey	4.902
DDBP4902AG	Anthracite Grey	4.902

## Deck Clip



Use Wood Screw Countersunk (DWSCREW30) P9

The deck must be supported by bearers and a deck clip used on each bearer at maximum centres of 450mm. Deck clips should be secured using 4.5mm x 30mm Stainless Steel counter sunk screws (Code - DWSCREW30). Where decking boards are not set at 90deg to the bearers the fixing centres of the decking board will naturally increase. This should be accounted for in bearer spacing in that area.

Code	Size	Pack
DTCLIP	40mm x 33mm	Bag 250



## Accessories

### Infill Trim

This trim clips neatly into the exposed edge of the outer board and can be used along the appropriate edge of the deck or along the front edge of a step.

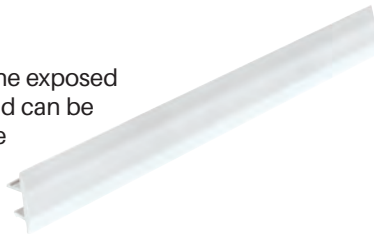

Code	Colour	Length (m)
DINFILL3000LO	Light Oak	3.0
DINFILL3000DO	Dark Oak	3.0
DINFILL3000MG	Moss Grey	3.0
DINFILL3000DW	Driftwood	3.0
DINFILL3000LN	Luna Grey	3.0
DINFILL3000AG	Anthracite Grey	3.0

### D Trim

A great looking, heavy duty profile that is used to cover exposed ends of the board around the edge of the deck. This will provide an all-round neater finish for DIYers.



Code	Colour	Length (m)
DDTRIM4902LO	Light Oak	4.902
DDTRIM4902DO	Dark Oak	4.902
DDTRIM4902MG	Moss Grey	4.902
DDTRIM4902DW	Driftwood	4.902
DDTRIM4902LN	Luna Grey	4.902
DDTRIM4902AG	Anthracite Grey	4.902

## General Accessories

### U-Channel (29mm x 29mm x 29mm)

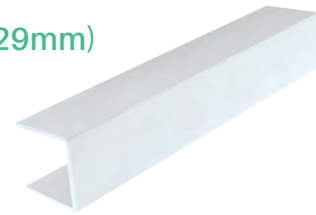

Code	Colour	Length (m)
DCHAN4876W	White	4.876
DCHAN4876_ _*	Foil	4.876

\*add colour code from swatches below

### Fixed Angle (40mm x 40mm)



Code	Colour	Length (m)
DFANG6000W	White	6.0
DFANG6000_ _	Foil	6.0

\*add colour code from swatches below

### Standard

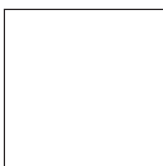

White (W)

### Foiled

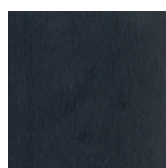

Anthracite Grey (AG)

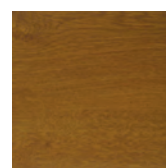

Golden Oak (GO)

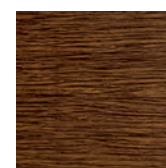

Rustic Oak (RO)\*



Natural Oak (NO)\*

\* Made to Order with Minimum Order Quantities

## BALUSTRADE

A traditional balustrade system that will complement our decking boards.

DekBoard balustrades can be made up in a number of ways, depending on your needs and deck style. You can choose traditional top and bottom rails with pickets in square/diamond format. Our balustrade system is compatible with glass but this is not supplied by DekBoard.

The hand rail and bottom rails should be reinforced with a metal insert that makes them very rigid and therefore able to take a lot of pressure from the side or above.

Our balustrade systems keep your family and friends safe around your garden decking.

Please consult the section on balustrade height to determine the right height for your installation.

### POSTS

- Always use a timber infill for posts of at least 95 x 95mm. Post infills may also be made up of 2 x 45mm x 95mm sections screwed together.
- Where the post is to be secured into a concrete or substantial timber base a post insert (DPOSTM) may be used (p7)
- Timber post infills should be set into concrete or mounted on to well set and well drained concrete or stone pads.
- Always treat the exposed end grain of such posts for long term protection.
- Slide the post cover over the timber post infills prior to fixing the deck subframe to the posts.
- Bearers may be screwed directly to posts or affixed using a recommended Sub-Frame Bracket (p7).

### 102mm x 102mm Post Sleeve

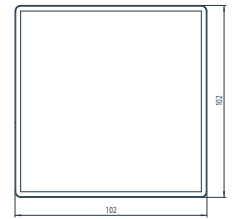

Code	Length (m)
DPOST1828W	1.828
DPOST4876W	4.876
DPOST4876_ _*	4.876

\*add colour code from swatches below

### Post Cap

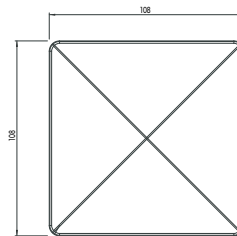
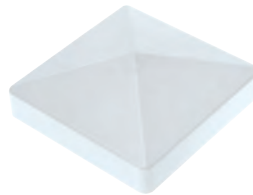

Code
DPOSTCW
DPOSTC_ _

### Post Skirt

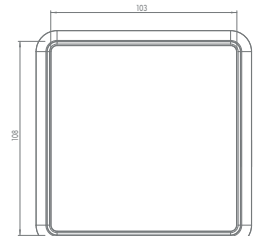

Code
DPOSTSW
DPOSTS_ _

### Standard



White (W)

### Foiled

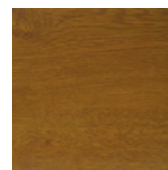

Golden Oak (GO)

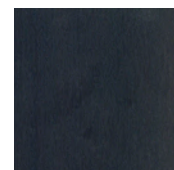

Anthracite Grey (AG)

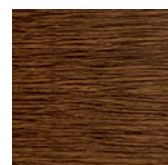

Rustic Oak (RO)\*



Natural Oak (NO)\*

\* Made to Order with Minimum Order Quantities

## Post Mount

Mark the location of the corner holes on the lower mounting plate and drill a 10mm hole into the substrate for each of the 4 corners in order to accept a suitable M8 Fixing Anchor or appropriate concrete screws.

Set up the correct angle for the Post Insert by adjusting the 4 bolts threaded through the upper mounting bracket. Insert the anchors through the corner holes of both plates on the Post mount as shown and press them into the substrate.

Once the final adjustment of the post position has been achieved ensure the anchors are bolted down and the lock nuts on the adjusting bolts are tightened up against the underside of the upper mounting plate.

Code	Length (m)
DPOSTM	0.76



## Sub Frame Bracket

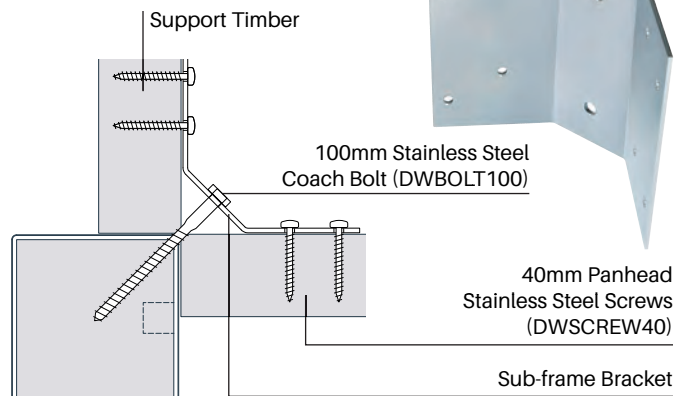

This bracket is used to secure the open corners of a sub-frame to a corner post.

Code	Length (m)
DSUBBK	100mm x 300mm

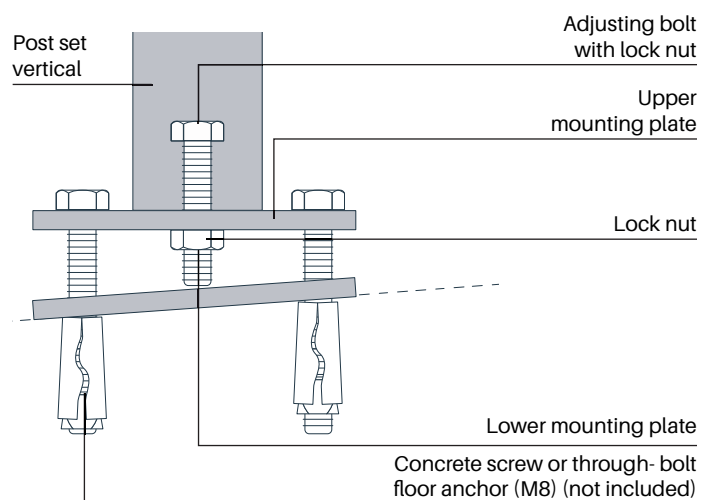

	Code	Units	Application	Notes
Coach Bolt (100mm)	DCBOLT	Box 50	Sub Frame Bracket to Post	13mm head Stainless Steel
Wood Screw Countersunk (90mm)	DWSCREW90	Box 100	General subframe assembly	Yellow plated- no pilot hole required (60mm of thread)
Wood Screw Countersunk (60mm)	DWSCREW60	Box 200	Fascia board to subframe Fix deck from below	Yellow plated- no pilot hole required
T Star Washer Head Screw (60mm)	Non stock item		Step Tread	Stainless steel
Wood Screw Countersunk (50mm)	DWSCREW50	Box 200	Fascia board with lath	Stainless steel
Wood Screw Pan Head (40mm)	DWSCREW40	Box 100	Sub-frame bracket to frame	Stainless steel
Wood Screw Countersunk (30mm)	DWSCREW30	Box 500	Deck Clips Fixed Position Rail Brackets	Stainless steel
L Clip	Non stock item		L Clip	19 x 19mm Steel Angle Brace

# BALUSTRADE SYSTEM

**Routing** - Top and bottom rails can be supplied in plain or routed format ready to accept the 32mm x 32mm picket.

The holes are routed square with the rail.

## Square - RS



## Standard



White (W)

## Foiled

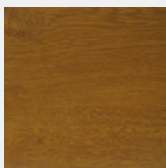

Golden Oak (GO)

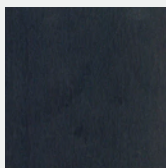

Anthracite Grey (AG)

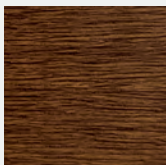

Rustic Oak (RO)\*

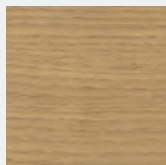

Natural Oak (NO)\*

\* Made to Order with Minimum Order Quantities

## Top Rail Plain and Routed

It is recommended that rail reinforcement is used on all top and bottom rails

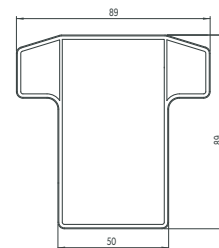

## Bottom Rail Plain and Routed

It is recommended that rail reinforcement is used on all top and bottom rails

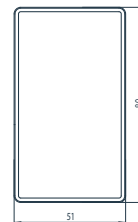

**Please note:** Top and bottom rails are ordered in pairs therefore identified as a single item

Code Square Rout	Code Plain - No rout	Length (m)
DTBRLRS1828W	DTRAIL1828W	1.828m
DTBRLRS1828_*	DTRAIL1828_*	1.828m
DTBRLRS2438W	DTRAIL2438W	2.438m
DTBRLRS2438_*	DTRAIL2438_*	2.438m

\*add colour code from swatches on right

## Height of balustrades

Balustrades on decking provide a decorative means of preventing falls.

Even a small change of level can be a hazard. Unless the deck surface is flush with the surrounding ground, a balustrade should be incorporated.

The height of the balustrade depends on how far the deck surface is off the ground:

For 'low-level' structures where the deck surface is up to 600mm from ground level, the hand rail height should be a minimum of 900mm above the deck surface.

For 'high-level' decks over 600mm high the balustrade height should be a minimum of 1100mm above the deck surface.

DekBoard standard balustrade components have been designed to meet the requirements for permitted developments with a deck height of up to 300mm.

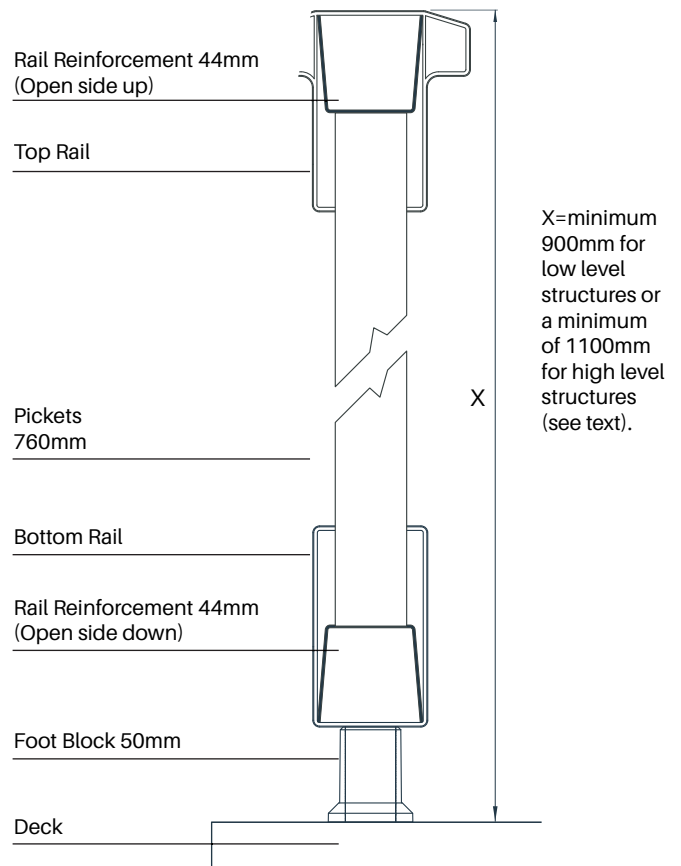

## Rail Reinforcement

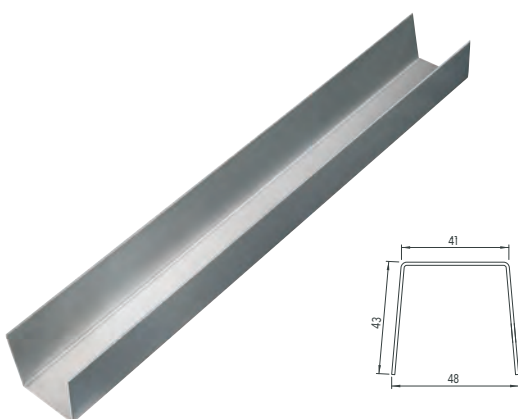

Code	Length (m)
DRBAR1828	1.828
DRBAR2438	2.438

## Foot Block

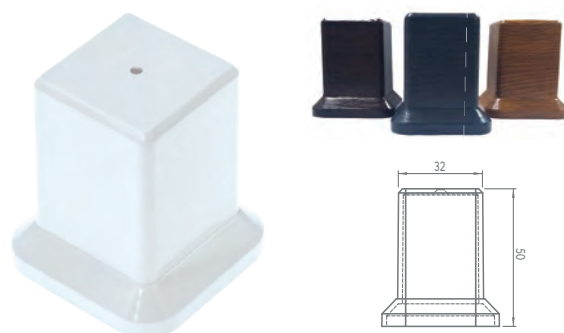

Code	Colour	Size
DFTBLKW	White	32mm x 50mm
DFTBLK_ _*	Foiled	32mm x 50mm

\*add colour code from swatches left  
Foiled Footblocks are \* Made to Order with Minimum Order Quantities

# BALUSTRADE SYSTEM

## Standard

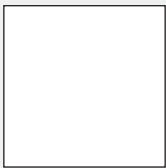

White (W)

## Foiled

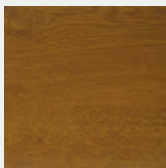

Golden Oak (GO)

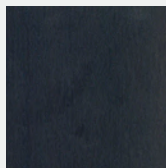

Anthracite Grey (AG)

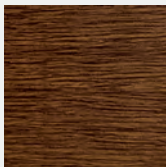

Rustic Oak (RO)\*



Natural Oak (NO)\*

\* Made to Order with Minimum Order Quantities

## Note -

- Fix the lower section of each bottom bracket in position first, ensuring that they are level. Pre-assemble the rails, reinforcing bar, and pickets (see p 9), set them into the bottom rail brackets and mark the position for the top rail brackets. Remove the rail assembly, fix the top rail brackets in place and reinstall the rail assembly. The top sections of each bracket simply clip into place. A screw must be fixed into the hole in the bottom of the bracket.
- Always check that the top brackets are fixed at the required balustrade height

## 32mm x 32mm Picket

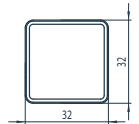

Code	Length (m)
DPICK10760W	0.760m
DPICK10760_ _*	0.760m
DPICK10834W	0.834m
DPICK10834_ _*	0.834m

\*add colour code from swatches

## 150mm x 25mm Fascia

The Fascia Board is used for facing off the edge of the deck in order to hide the timber bearers. The boards can be secretly fixed from behind using 60mm woodscrew DWSCREW60 (p9) assuming that the timber substructure is at least 40mm deep. Always leave gaps between boards for ventilation.

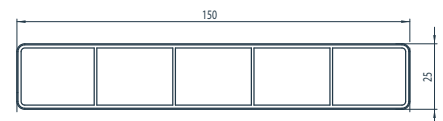
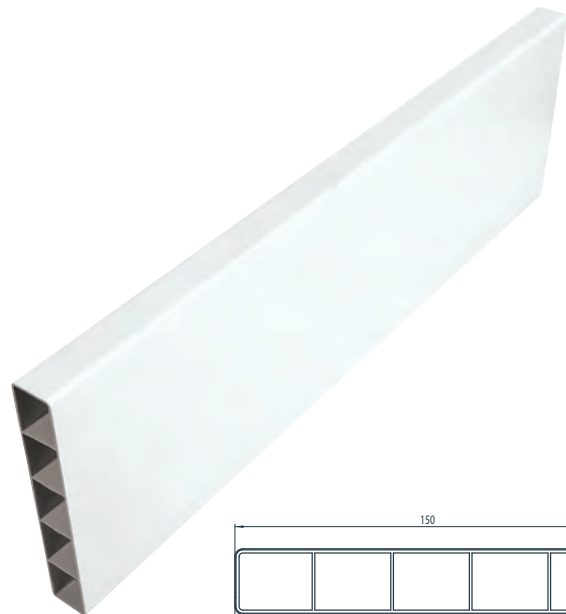

Code	Length (m)
DPICK64876W	4.876m
DPICK6PF4876_ _*	4.876m

\*add colour code from swatches on Pg9

## DEKBOARD Brackets

Top rail and bottom rail brackets are needed to fix the rails to the posts. Brackets are available as fixed position units in straight format, in 30deg (up or down) format or in multi angle (horizontal or vertical) format.

### Top Rail Bracket Straight



Code	Colour
DTOPRBKTW	White
DTOPRBKT_ _ *	Foiled

\*add colour code from swatches

### Bottom Rail Bracket Straight



Code	Colour
DBOTMBKTW	White
DBOTMBKT_ _ *	Foiled

### Top Rail Stair Bracket Kit 30° 1 x up 1 x down



Code	Colour
DTSTAIRW	White
DTSTAIR_ _ *	Foiled

\*add colour code from swatches

### Bottom Rail Stair Bracket Kit 30°D 1 x up 1 x down



Code	Colour
DBSTAIRW	White
DBSTAIR_ _ *	Foiled

## Gates

We recommend that a gate is fitted to all raised deck platforms. With self-closing hinges and lockable latches these gates provide a safe enclosure for children and a deterrent to others.

The holes are routed square with the rail.

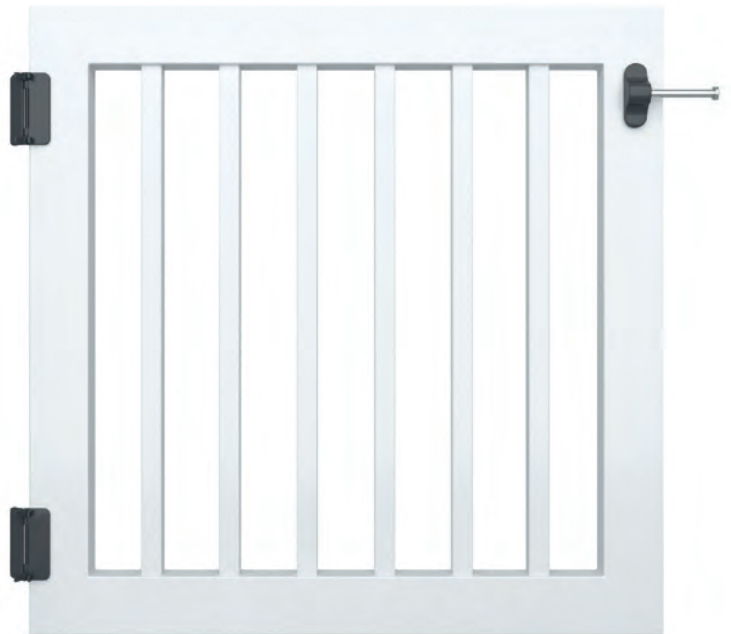

(Fittings not included)

Our standard gate size is 960mm (w) x 950mm (h) for domestic use.

Please contact us to enquire about alternative sizes.

Code	Colour	Pack Qty
DGATEW	White	1
DGATE_ _	Foiled*	1

## Hinges

Pair of self-closing hinges to ensure that the gate always returns to a closed position. Super strong engineering polymer and stainless steel construction.



Code	Colour	Pack Qty
DHINGE	Black	1 pair

## Latch

Single side secure, key-lockable latch. Adjusts horizontally and vertically to account for any gate movement.



Code	Colour	Pack Qty
DLATCH	Black	1 pair



## Maintenance and Aftercare

It is vital that all decks are maintained correctly to ensure that they stay in optimum condition. We recommend the following things:

- Regularly wash all balustrade, hand rails and posts using warm water and mild detergent **ONLY**
- Use a stiff bristled brush to clean the deck boards, again using warm water and mild detergent **ONLY**
- You may also use a domestic jet wash to clean the deck boards **ONLY**

We recommend that you **DO NOT** do the following things:

- Scrub any of our products with abrasive papers, such as sandpaper etc
- Clean the deck boards or balustrades with any type of bleach or solvent
- Use of glass cleaner on any PVC-u components

### Additional Tips:

- Any hot surface such as barbeques or similar should not be on or close to PVC-u decking construction.
- Please be aware that some rubber - backed mats can cause discolouration of deck boards over time
- Some brands of sun cream can permanently stain foiled balustrade finishes

All installations should be inline with our Trade Installation Guide recommendations



# DEKBOARD

## Plan your deck

Use this handy space to plan a deck that suits your garden area.

Start by drawing the area you'd like to deck out and then work out the number of boards required.

Our board length is 4902mm and the width is 145mm. Each board has a 5mm gap between it and the next board (this gap is created by the decking clips), so the cover width is 150mm. Therefore, each board covers 0.735 of a square metre (ie approximately 3/4 sqm).

To work out the number of boards that are required, just calculate the number of square metres your deck will cover, then divide that number by 0.735

### Example:

A deck of 5m x 4m has an area of 20sqm.

The number of boards needed is  $20 \div 0.735 = 27.2$  boards. You should also allow 12 to 14 decking clips per decking board.

**Important** - This calculation is an approximate guide. Very few decks are nicely rectangular and so you'll have to allow for odd areas that may require you to cut the boards in ways that create more wastage than this simple calculation allows for. Therefore you should allow for at least

10% wastage. In some circumstances it may be helpful to tailor the size of your deck to make the most of each board length.

Remember that the following basic principles of setting out the boards may affect the number of boards you'll need to use:

Run the boards across the most common line of tread, not with it.

Separate all joints on adjacent boards by at least 2 bearers.

All deck pieces should be long enough to be secured to at least 3 bearers.

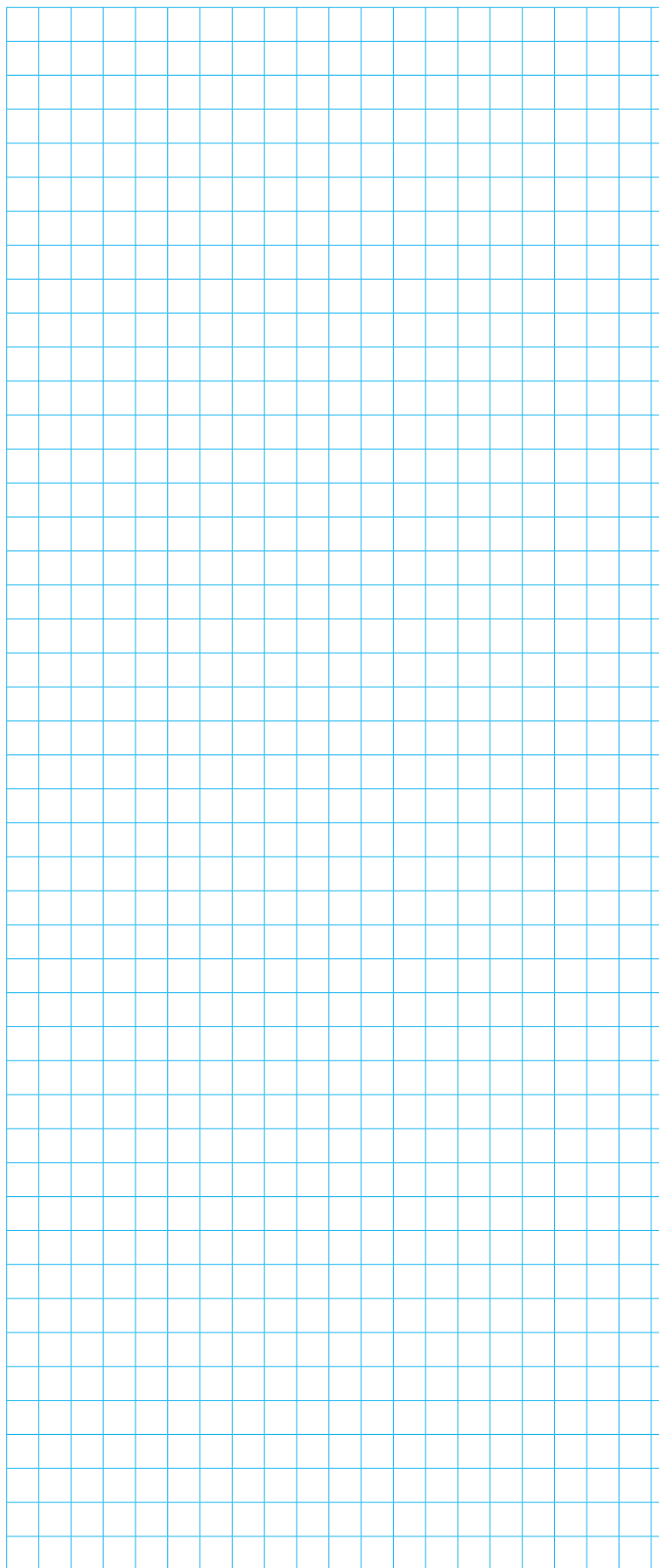

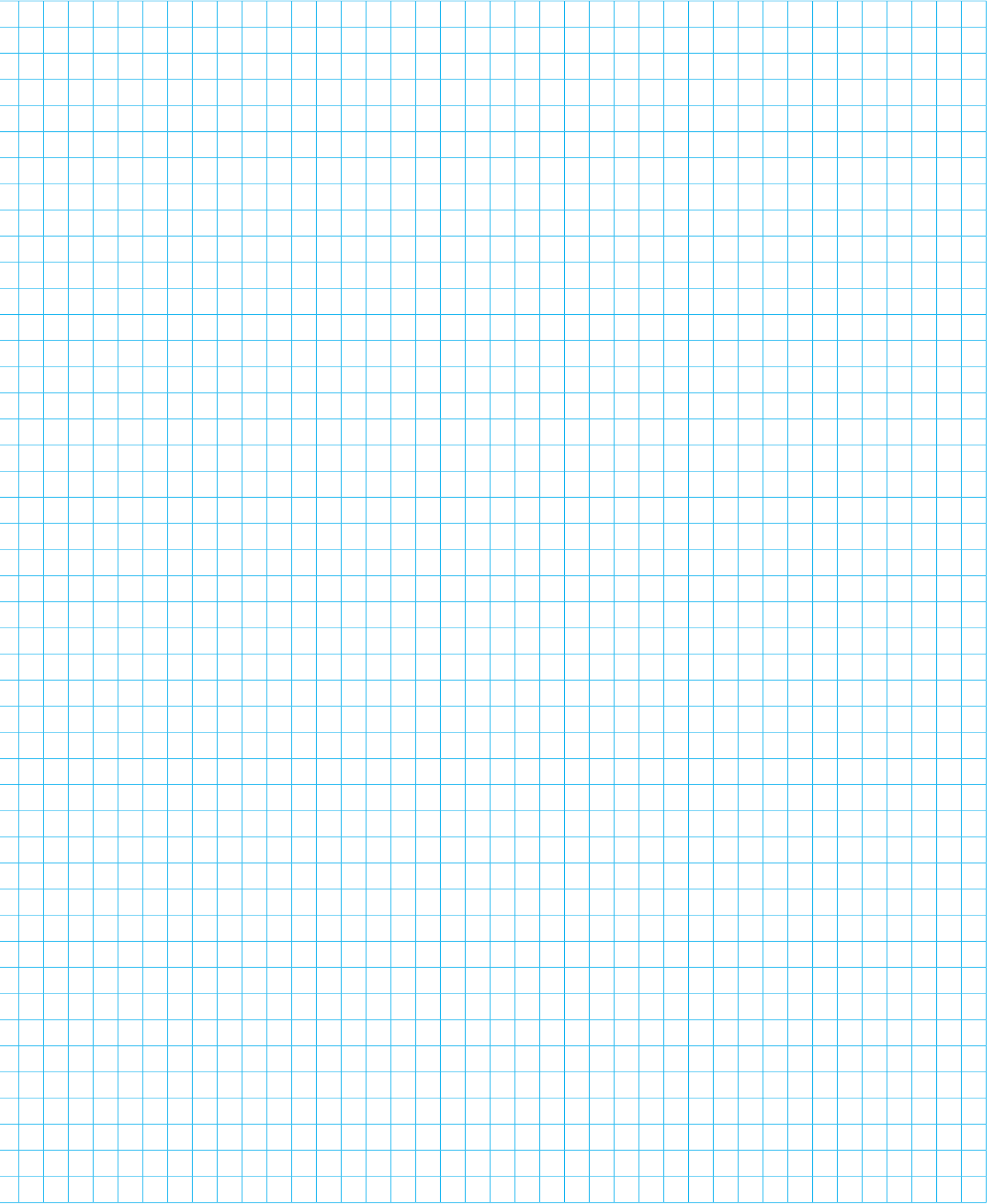



Robust

### Robust

- Strong construction
- Wear & impact resistant
- Will not warp like timber
- Low sound levels



Slip Resistant

### Safety

- Low slip surface in wet or dry conditions
- Will not crack or splinter
- Will carry high loads
- No sharp edges or splinters



Low Maintenance

### Low Maintenance

- Easily cleaned
- Unlike timber it won't promote mould growth
- Doesn't need treating, varnishing or painting



100% Recyclable

### Environmental

- 100% Recyclable
- No paints or preservatives required
- Manufactured under ISO14001 Environmental Management Certification



Long Life

### Long Life

- Will not rot
- Does not require maintenance
- 10 year performance guarantee
- Outlasts timber



Product Testing

### Product Testing

- Fire Classification - BS EN 13501-1 : 2008
- Slip Resistance: BS7976 - 2
- Load Span: ref BS EN 1991-1-1 : 2002

# DEKBOARD®

Billet Lane  
Normanby Enterprise Park  
Normanby Road  
Scunthorpe  
North Lincolnshire  
DN15 9YH

01724 848500  
sales@dekboard.co.uk



www.dekboard.co.uk

Due to the limitations of the printing process the swatches and photography in this brochure should be taken as a guide and not an accurate representation of the actual product colour.

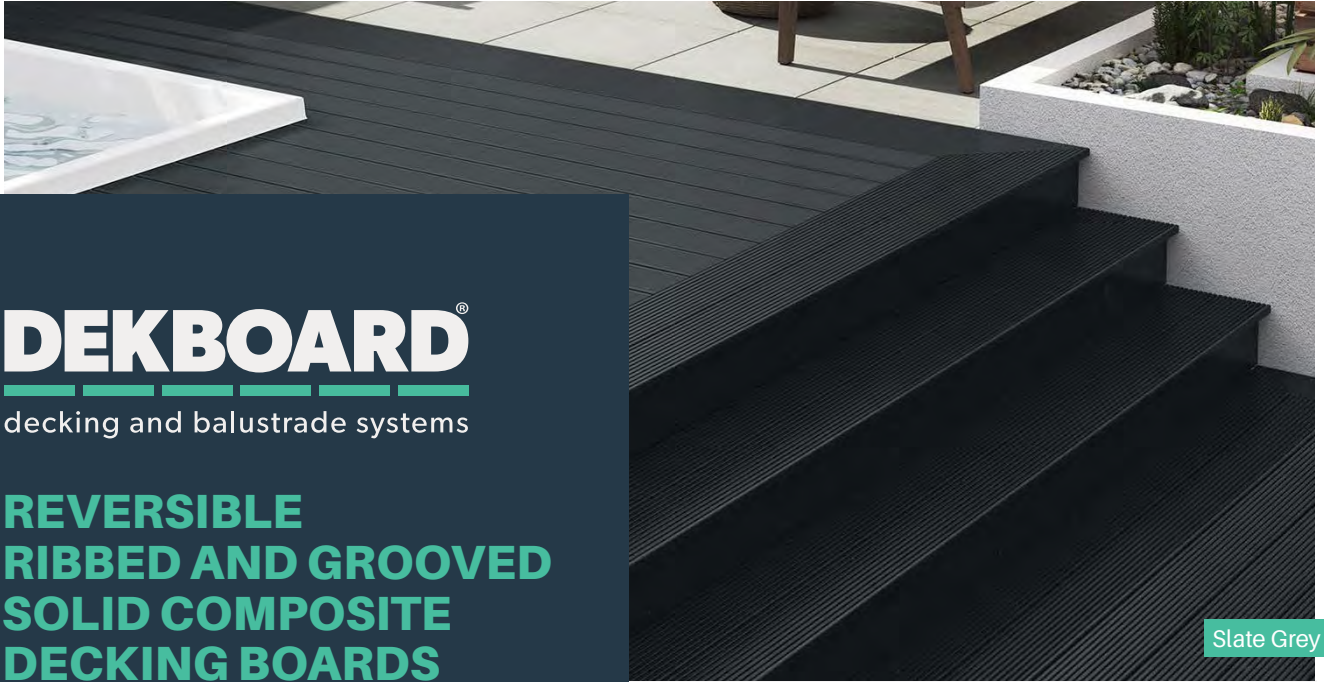

Slate Grey

# DEKBOARD®

decking and balustrade systems

## REVERSIBLE RIBBED AND GROOVED SOLID COMPOSITE DECKING BOARDS

DekBoard reversible composite decking offers the appeal of timber with none of the hassle. Manufactured from an eco-friendly Wood Polymer Composite material, this decking has a low slip potential and is suitable for use in both residential and commercial landscaping projects

### Colour options

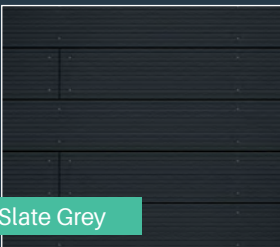

Slate Grey

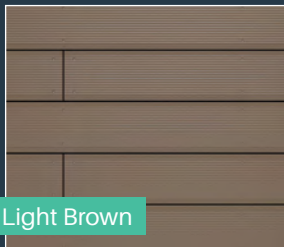

Light Brown

Our stylish boards offer a number of great features.



#### Slip resistant

With high levels of slip resistance, our boards are designed to keep you safe in different conditions.



#### Low maintenance

We truly understand the value of your time, meaning that our decking will not need sanding or sealing and is easy to clean.



#### Splinter free

With both style and safety in mind, our boards are designed to be tough, durable and splinter free.



#### Rot & split resistant

Our high-quality boards are carefully made to last and will not rot or split.



#### Warranty

25 Year structural product warranty



#### Recycled content

Made from 95% recycled and sustainably sourced materials.

dekboard.co.uk

Decking

Contact us today for a free quote or for more information:

Tel: 01724 848500 | Email: sales@dekboard.co.uk

# DekBoard Reversible Composite Decking

## Specification

Standard length:	3.6m	Material:	Wood polymer composite	Coverage:	0.5m <sup>2</sup>
Profile height:	21mm	Solid board:	Yes	Warranty:	Residential - 25 years*
Profile width:	136mm	Finish:	Ribbed or Grooved	Warranty:	Commercial - 25 years*
** MOQs apply		Reversible:	Yes	Weight:	3.0kg/m
				*Warranty	

### Deck board profile



21mm x 136mm – Grooved / Ribbed Reversible  
 3.6m standard stocked length  
 Designed for use with face fixings

### Fascia board profile

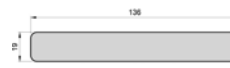

19mm x 136mm  
 3.6m lengths  
 To create a neat finish to the deck sides



Light Brown

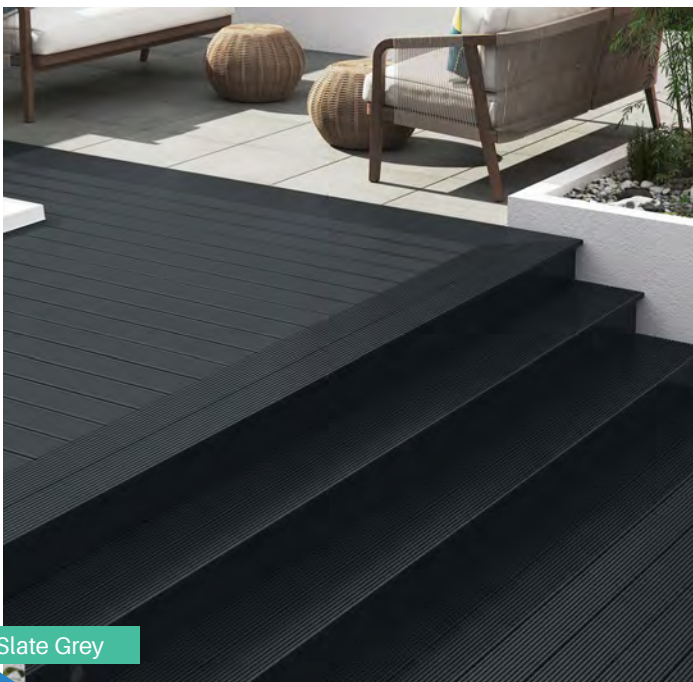

Slate Grey

# DEKBOARD®

Normanby Enterprise Park  
 Billet Lane  
 Scunthorpe  
 North Lincolnshire  
 DN15 9YH

01724 848500  
[sales@dekboard.co.uk](mailto:sales@dekboard.co.uk)  
[dekboard.co.uk](http://dekboard.co.uk)



Due to the limitations of the printing process the swatches and photography in this leaflet should be taken as a guide and not an accurate representation of the actual product colour.

Enjoy a relaxing, personal oasis with Fiberon® Sanctuary decking. Beautiful and easy to maintain, Sanctuary decking features bold, multi-tonal colours and rustic embossing with an innovative PermaTech® cap layer for superior stain and fade resistance.

- Three-sided PermaTech cap layer resists fading.
- The flat-profile bottom provides a sturdy feel, reminiscent of traditional lumber.
- Strong composite construction resists splintering, rotting, cracking, insects and decay.
- Contains 95% recycled content.



Square Edge = 24mm x 135mm.  
Length: 4.88m.



Grooved Edge = 24mm x 135mm.  
Lengths: 3.66m and 4.88m.



Fascia: .18mm x 285mm.  
Lengths: 3.66m and 4.88m.



Sanctuary composite decking in Chai.

Actual colours may vary from photographs.

fiberon® Sanctuary®

Exclusive to  
DekBoard in the UK



40  
Year  
Stain, Fade, and  
Performance  
Limited Residential Warranty

Backed by a 40-year performance warranty  
and a 40-year stain and fade warranty.

Sanctuary composite decking in Earl Grey.

Actual colours may vary from photographs.

**DEKBOARD®**

Fiberon exclusive to DekBoard in the UK

Visit [dekboard.co.uk](https://dekboard.co.uk) for more details or email [info@dekboard.co.uk](mailto:info@dekboard.co.uk)

Note: Visit [dekboard.co.uk](https://dekboard.co.uk) for details on limited warranties and exclusions





Good Life composite decking,  
Escapes Collection in Bungalow.

Take time to unwind with Fiberon® Good Life decking. Perfect for hosting neighborhood gatherings, enjoying a summer dinner with your family or relaxing outside after a long week, Good Life offers unbeatable performance and durability for your decking project needs.

- Escapes Collection features multi-tonal colours that resemble exotic hardwoods.
- Authentic wood look features distinct grain patterns.
- Durable, long-lasting and priced closer to wood.
- Composite construction prevents splintering, cracking and decay.
- Three-sided cap layer resists staining and fading.
- Low maintenance and easy to clean.
- Contains 96% recycled content.



Square Edge = 24mm x 135mm  
Lengths: 3.66m



Grooved Edge = 24mm x 135mm  
Lengths: 3.66m and 4.88m

## Escapes Collection

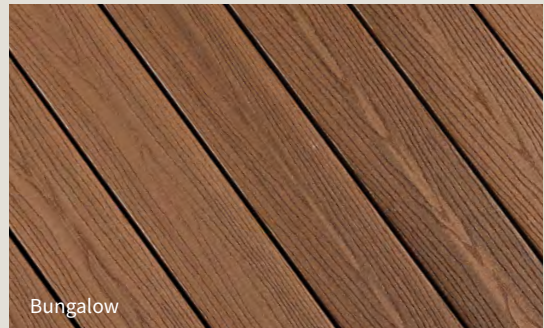

Bungalow



Beach House

Actual colours may vary from photographs.



**30**  
Year  
Stain and Fade  
Performance  
Limited Residential Warranties

The Good Life Escapes Collection is backed by a 30-year performance warranty and a 30-year stain and fade warranty.

Good Life composite decking,  
Escapes Collection in Beach House.



Good Life composite decking,  
Escapes Collection in Bungalow.

Actual colours may vary from photographs.

**DEKBOARD**<sup>®</sup>

Fiberon exclusive to **DekBoard** in the UK

Visit [dekboard.co.uk](http://dekboard.co.uk) for more details or email [info@dekboard.co.uk](mailto:info@dekboard.co.uk)

Note: Visit [dekboard.co.uk](http://dekboard.co.uk) for details on limited warranties and exclusions

# Business Development Manager: Area Coverage

## Scotland, Ireland & North East

Mobile: 07766 246326

## North West & North Wales

Mobile: 07818 043640

## East Anglia & North London

Mobile: 07917 616682

## Midlands, South West & South Wales

Mobile: 07813 436956

## South East and South Coast

Mobile: 07976 531502

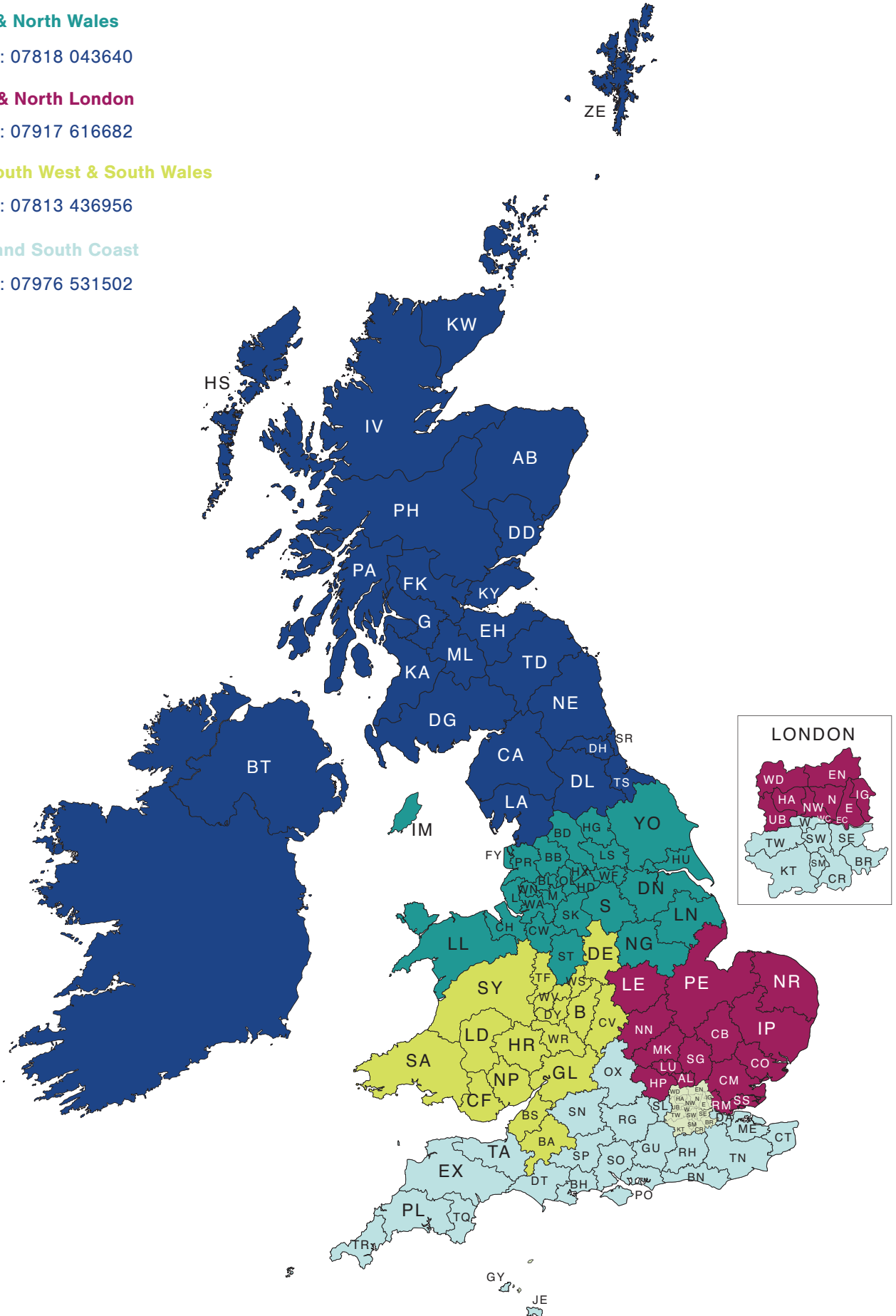

## Kestrel Customer Services

Kestrel has a dedicated Customer Services Team to help distributors and stockists to place their orders or if you have any order / dispatch related enquiries.

Customer Services are available  
8.30am to 5.15pm Monday to Thursday  
8.30am to 5pm on Fridays.

Tel:  
+44 (0)8702 406107  
or  
+44 (0)8702 406197

Fax: +44 (0)8702 406116 or +44 (0)8702 406113

Order related enquires please email:  
[kestrel.sales@kestrelbce.co.uk](mailto:kestrel.sales@kestrelbce.co.uk)

For all general enquiries email:  
[info@kestrelbce.co.uk](mailto:info@kestrelbce.co.uk)

## Estimating Enquiries

Specification Tel : 01724 400 454  
Specification Fax : 01724 280 241  
Specification email : [spec@kestrelbce.co.uk](mailto:spec@kestrelbce.co.uk)



This document is printed on environmentally friendly paper

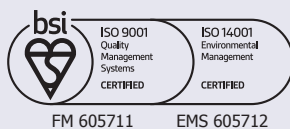

June 2022



[www.kbp.co.uk](http://www.kbp.co.uk)

**KESTREL**  
rely on it